

New Viking™ 3, the innovation

Screw or automatic spring connection

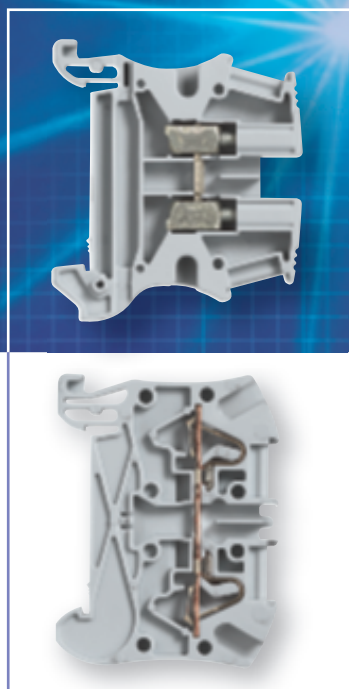

A NEW RANGE,
BORN OF RESEARCH & EXPERIENCE

 **legrand**®

INDEX

—▶ Screw connection	2
—▶ Automatic spring connection	4
—▶ Common accessories	6
—▶ Catalogue pages	8
▶ Selection table	8
▶ Viking 3	14
▶ CAB 3 marking and isolating sleeves	26
▶ CAB 3 marking system	27
▶ Starfix ferrules and crimping tools	30



For over 30 years, Legrand has produced Viking 3 screw terminal blocks in its Normandy factories for the whole world. Millions of wiring installers have used the different generations. They are constantly providing ideas for improvement which today make them a benchmark in the connection field.

Viking 3 terminal blocks are the core of a reliable and easy to use connection system, together with CAB 3 marking system and Starfix ferrules and crimping tools.

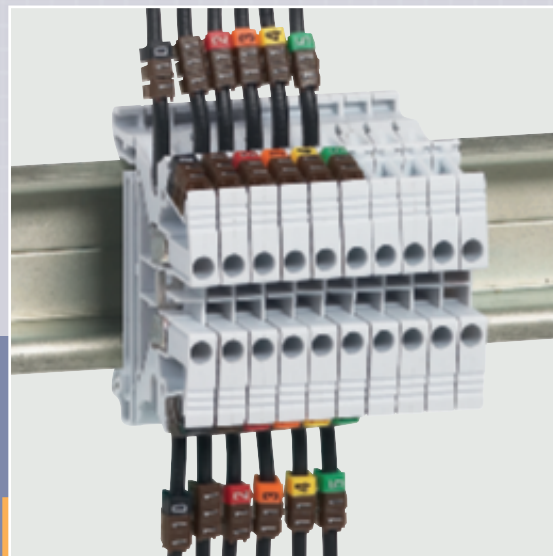

Viking 3 terminal blocks and their CAB 3 marking system

Strength and security:

High contact pressure
using the clamp/bar
system

Captive screw

Excellent mechanical strength
with a specially selected clamp
made of surface-treated steel ⁽¹⁾

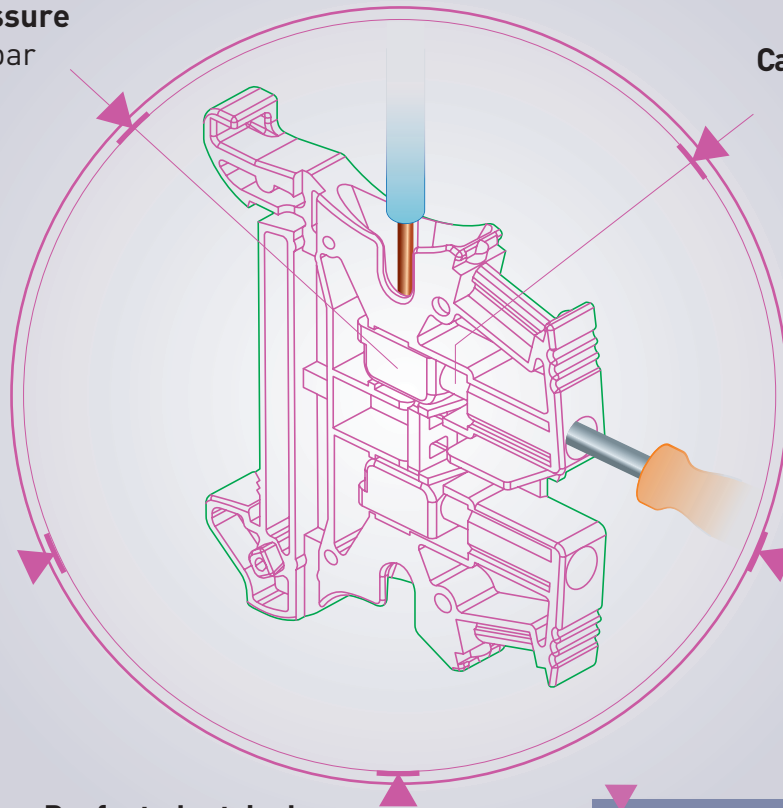

Clamping tried and tested for strength, pulling-out, destructive torque resistance and ageing

Perfect electrical conduction with the tinned brass bar ⁽¹⁾

Permissible cross-sections:
0.25 mm² to 70 mm²
(flexible wire) and 0.25 mm²
to 95 mm² (rigid wire)

⁽¹⁾ Complies with RoHS (Restriction of Hazardous Substances) requirements

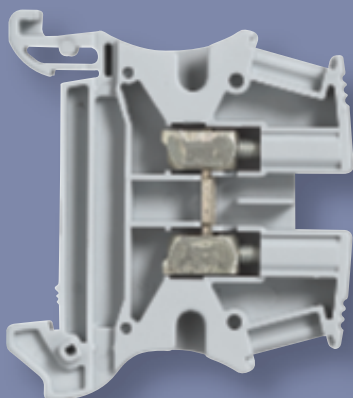

International approvals:
UL/CSA/NF/VDE/IMQ/BV
ATEX certification



Conforms to IEC EN 60947-7-1,
IEC EN 60947-7-2 and IEC EN 60947-7-3

screw connexion

▶ The other innovations

Optimized size, simplified fixing and standardized end caps systems bring comfort of use for the new Viking 3 range and make installation, connection and marking easier than ever.

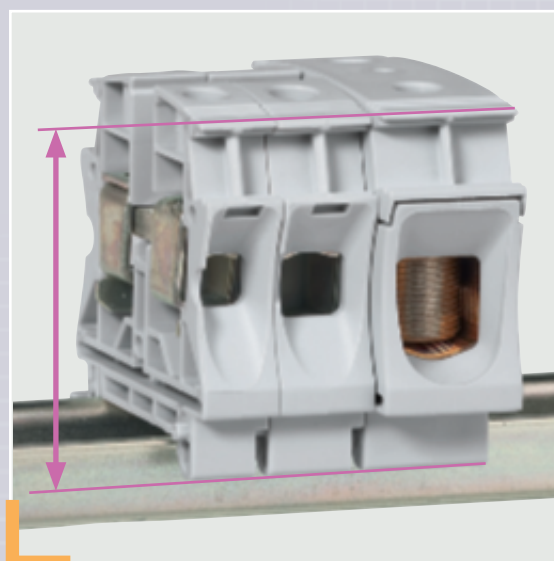

Identical height for blocks of 16 mm² to 70 mm²

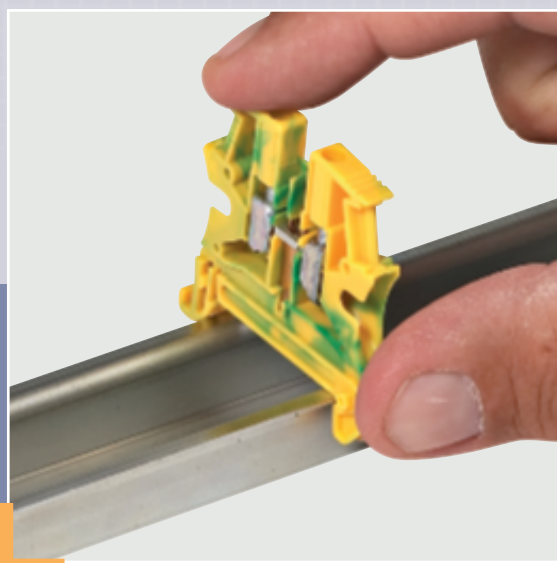

Direct screwless fixing on  rail for protection conductor modules (for pitches of 5 to 10)

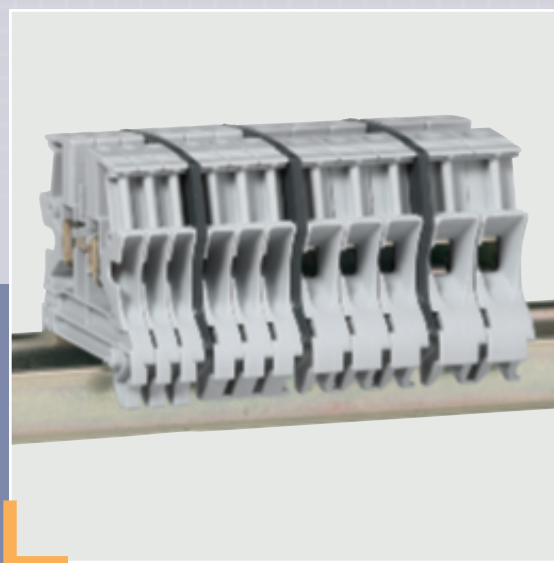

Single end caps for pitches of 5 to 10

Reliability and time saving:

No tool required for connection:

Direct insertion ⁽¹⁾ up to pitch of 6.
Disconnection with screwdriver

Constant contact pressure

Better management of wires with the inclined cable entries

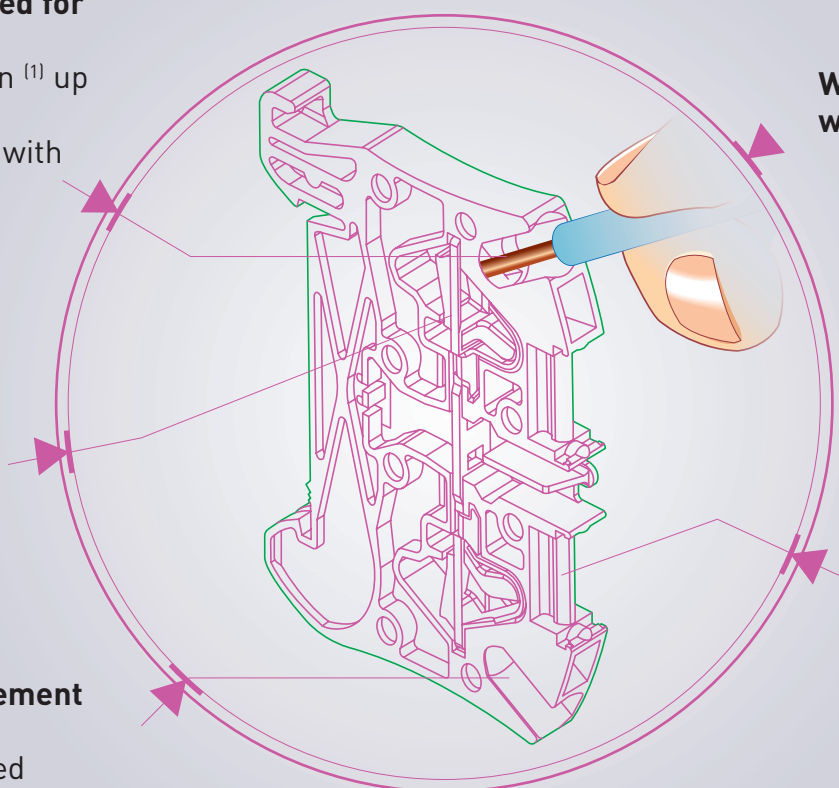

With or without ferrule

Double central marking area

Permissible cross-sections:
0.5 mm² to 16 mm²

[1] For a flexible wire with no ferrule, the spring is opened using a screwdriver

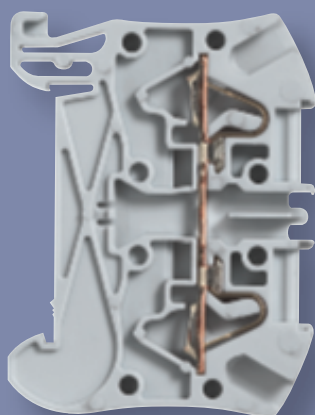

International approvals:
UL/CSA/NF/VDE/IMQ/BV
ATEX certification



Conforms to IEC EN 60947-7-1,
IEC EN 60947-7-2 and IEC EN 60947-7-3

automatic spring connection

▶ The other innovations

Actively listening to installers has resulted in Legrand's Research & Development department creating an innovative new Viking 3 spring terminal block which, over and above connection quality, has many advantages.

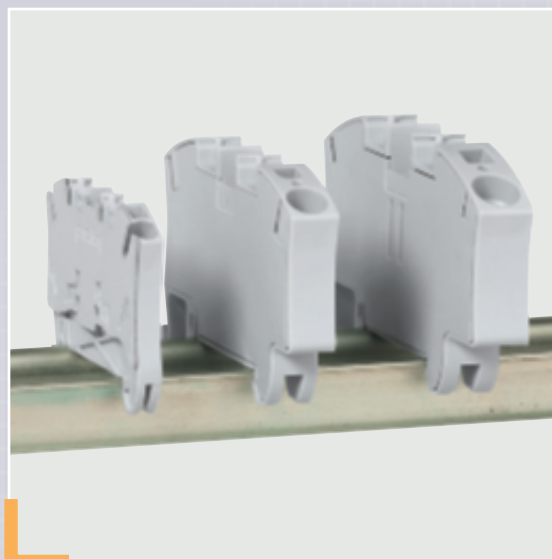

Integrated end caps for pitches of 6 to 12

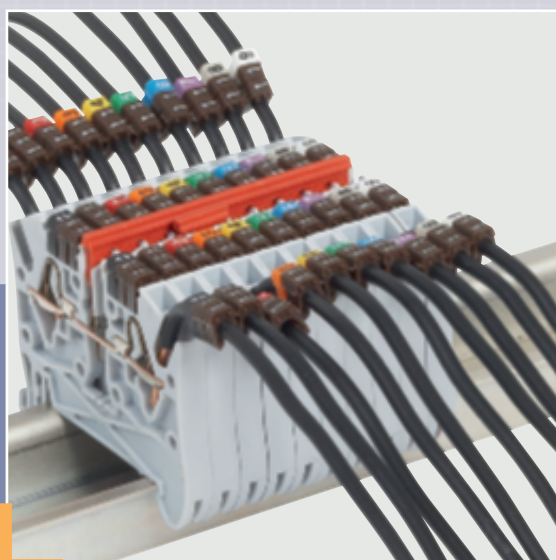

Bridging combs and markings are perfectly visible

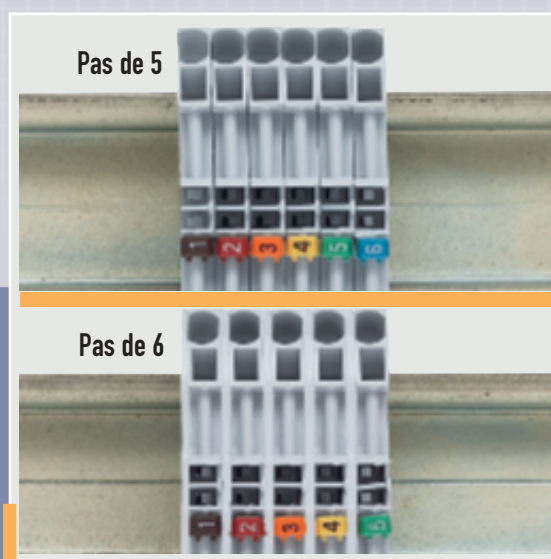

Optimized terminal block size. Identical electrical characteristics for blocks with a pitch of 5 and those with a pitch of 6 (one block gained every 5 blocks with a pitch of 5)

Screw or automatic spring: more convenient wiring and easier use

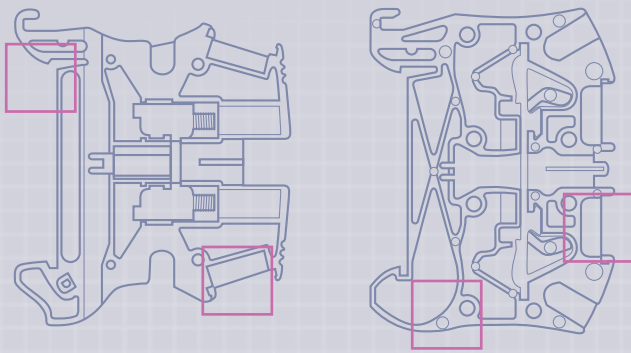

End stop: screwless fixing

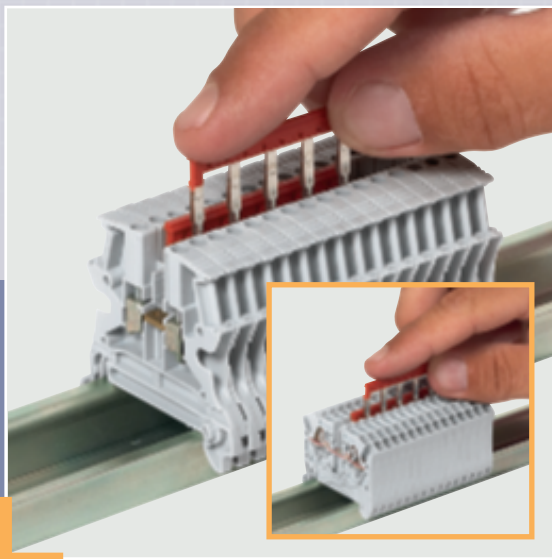

Automatic-insertion bridging comb up to pitch of 8, 2 areas allowing pitch jumps

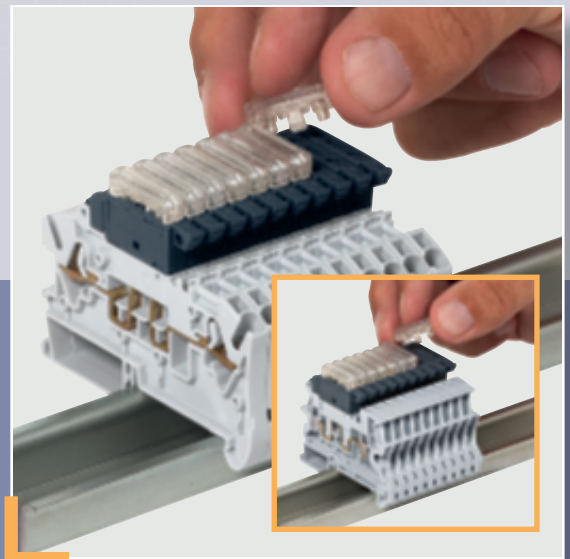

Blown fuse indicator can be added at the last moment (12/48 V or 110/250 V)

thanks to common accessories.

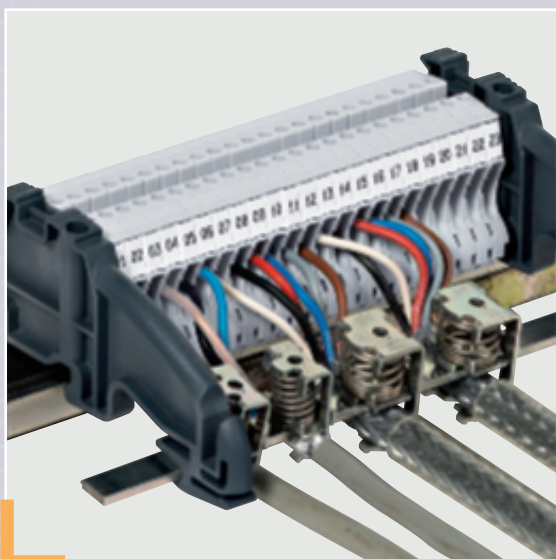

Managing cable shielding with dedicated accessories

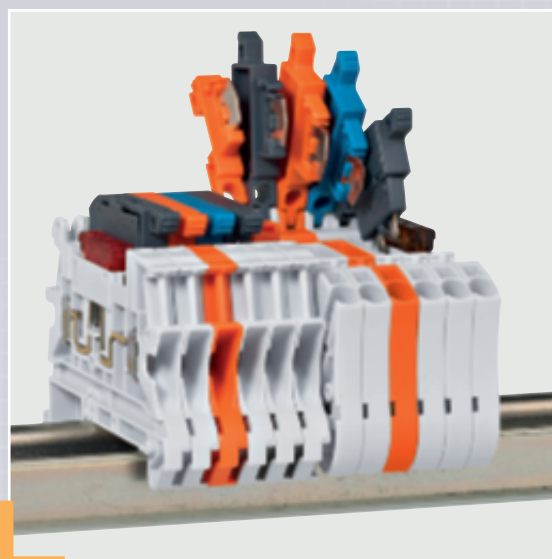

Addition of functions on module for equipping: standard, neutral or protected isolation, mini-circuit-breaker, automotive-type fuse, etc.



Possibility of either manual marking (CAB 3)...

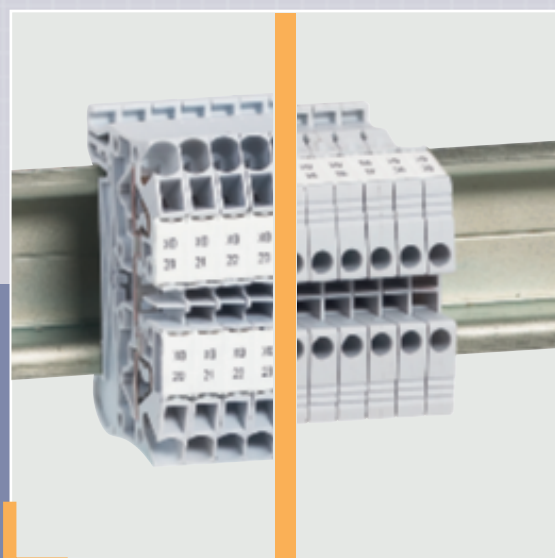

...and computerized (Logicab 2)

Viking™ 3 terminal blocks with screw connection and accessories

NEW



ELECTRICAL FUNCTION



371 61 371 63 371 64 371 66 371 69 371 68 371 00 371 08 371 20 371 30	<p>Connecting (p. 14)</p>	<p>1 connection - 1 entry/1 outlet</p> <p>1 connection - 2 entries/2 outlets</p> <p>2 connections on 2 levels</p> <p>3 connections on 3 levels</p>	
371 71 371 76 371 78 371 79	<p>For protection conductor (p. 14)</p>	<p>1 connection - 1 entry/1 outlet - metal base</p> <p>1 connection - 1 entry/1 outlet - plastic base⁽¹⁾</p> <p>1 connection - 2 entries/2 outlets - metal base</p>	
371 80 371 81 371 84 371 86 371 87	<p>Disconnect (p. 15)</p>	<p>1 connection</p> <ul style="list-style-type: none"> Open (to be equipped) For fuse cartridge 5 x 20 with handle lever For fuse cartridge 5 x 20 with handle lever + blown fuse indicator For neutral circuit with handle lever For standard circuit <ul style="list-style-type: none"> With handle lever With mini lever For circuit not broken <ul style="list-style-type: none"> With handle lever With mini lever For fuse cartridge 5 x 20 with screwed plug For fuse cartridge 6.3 x 32 with screwed plug 	
371 53 371 56	<p>Function blocks (p. 15)</p>	<p>1 connection</p> <ul style="list-style-type: none"> Modular Diode carrier 1N4007 <p>2 connections on 2 levels</p> <ul style="list-style-type: none"> Diode carrier 1N4007 With voltage presence LED 	
371 51 371 52 371 92	<p>For sensor and actuator (p. 15)</p> <p>PNE (p. 14)</p> <p>Measurement (p. 15)</p>	<p>3 connections on 3 levels</p> <ul style="list-style-type: none"> Sensor Actuator Phase/Neutral/Earth <p>1 connection</p> <ul style="list-style-type: none"> Disconnect for measuring circuit 	

(1) Can be used for protection conductor inside class II equivalent assemblies
 (2) Blown fuse indicator 12/24/48 V ~ / ~ Cat.No 375 24 or 110/250 V ~ Cat.No 375 25
 (3) Or end stop Cat.No 375 10

(4) Upper level
 (5) Lower level only
 (6) Lower and intermediate levels

Red catalogue numbers: New products

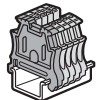
Old range (p. 12-13) available while stocks last

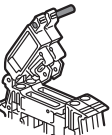
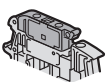
TERMINAL BLOCK				INSULATION		EQUIPOTENTIAL LINK					PROTECTION		MEASURE- MENT	ASSOCIATED PRODUCTS							
Nominal cross-section (mm ²)	Pitch (mm)	Colour	Cat. Nos	End cap	Separation and insulation divider	Comb for 2 blocks, auto. front	Comb for 3 blocks, auto. front	Comb for 10 blocks, auto. front	Comb for 12 blocks, side	Bar for 12 blocks, front	Single pole screen	Cut to length screen	Test socket								
2.5	5		371 60	375 50 ⁽³⁾	375 60	375 02		375 01			375 65	375 68	375 27	 End stops (p. 18)							
			371 00																		
			371 20																		
			371 30																		
4	6		371 61	375 50 ⁽³⁾	375 60	375 05		375 04			375 65	375 68	375 27	 Label holder for end stop (p. 18)							
			371 01																		
			371 21																		
			371 31																		
6	8		371 62	375 50 ⁽³⁾	375 60	375 08	375 07				375 66	375 68	375 27								
			371 78																		
10	10		371 63	375 50 ⁽³⁾	375 60					375 40	375 66	375 68	375 75								
			371 03																		
16	12		371 64	375 51	375 61					375 42	375 67	375 69	375 76								
			371 04																		
35	15		371 65	375 51	375 61					375 44	375 67	375 69	375 76	 Handle lever mini lever (p. 19)							
			371 05																		
70	22		371 66	built-in																	
4	6		371 69	375 52	375 62	375 05		375 04					375 27								
			371 09																		
2.5	5		371 67	375 53	375 63	375 02		375 01					375 27 ⁽⁴⁾								
			371 07																		
4	6		371 68	375 53	375 63	375 05		375 04					375 27 ⁽⁴⁾	 Joining rods for disconnect blocks (p. 19)							
			371 08																		
2.5	5		371 51	375 54	375 54	375 02 ⁽⁴⁾		375 01 ⁽⁴⁾	375 46 ⁽⁶⁾	375 47 ⁽⁶⁾			375 27 ⁽⁴⁾								
2.5	5		371 70	375 50 ⁽³⁾																	
4	6		371 71																		
6	8		371 72																		
10	10		371 73																		
16	12		371 74																		
35	15		371 75																		
35	15		371 76																		
4	6		371 77	375 50 ⁽³⁾	375 60	375 05		375 04			375 65	375 68		 Blown fuse indicators (p. 19)							
			371 78	375 50 ⁽³⁾	375 60	375 08	375 07			375 66	375 68										
4	6		371 79	375 52																	
2.5	6		371 80	375 55	375 62	375 05		375 04					375 27								
			371 81																		
			371 81 + 375 24/25 ⁽²⁾																		
			371 82																		
			371 83																		
			371 84												375 55	375 62	375 05		375 04		375 27
			371 85												375 55	375 62	375 05		375 04		
			371 86												375 55	375 62	375 05		375 04		375 27
10	12		371 87	375 56																	
			371 88																		
2.5	5		371 53	375 55		375 02		375 01					375 27								
			371 54																		
4	6		371 55	375 53	375 63	375 05		375 04					375 27 ⁽⁴⁾								
			371 56												375 05 ⁽⁵⁾	375 04 ⁽⁵⁾					
2.5	5		371 51	375 54	375 54	375 02 ⁽⁴⁾		375 01 ⁽⁴⁾	375 46 ⁽⁶⁾	375 47 ⁽⁶⁾			375 27 ⁽⁴⁾								
			371 52																		
4	8		371 92	375 57										375 77							

Viking™ 3 terminal blocks with spring connection and accessories

NEW

for copper cable



ELECTRICAL FUNCTION

372 60 372 61 372 64 372 40 372 69 372 68 372 02 372 47 372 21 372 42	<p>Connecting (p. 16)</p>	<p>1 connection - 2 wires - 1 entry/1 outlet</p> <p>1 connection - 3 wires - 1 entry/2 outlets</p> <p>1 connection - 4 wires - 2 entries/2 outlets</p> <p>2 connections - 4 wires - 2 levels</p>	
372 70 372 71 372 72 372 12	<p>For protection conductor (p. 16)</p>	<p>1 connection - 2 wires - 1 entry/1 outlet - metal base</p> <p>1 connection - 3 wires - 1 entry/2 outlets - metal base</p> <p>1 connection - 4 wires - 2 entries/2 outlets - metal base</p>	
372 80 372 82 372 83 372 84	<p>Disconnect (p. 17)</p>	<p>1 connection 2 wires</p> <p>Open (to be equipped)</p> <p>For fuse cartridge 5 x 20 with handle lever</p> <p>For fuse cartridge 5 x 20 with handle lever + blown fuse indicator</p> <p>For neutral circuit with handle lever</p> <p>For standard circuit</p> <p>For circuit not broken</p> <p>With handle lever</p> <p>With mini lever</p> <p>With handle lever</p> <p>With mini lever</p>	
372 54	<p>Function blocks (p. 17)</p>	<p>1 connection 4 wires 2 entries/2 outlets</p> <p>Diode carrier 1N4007</p> <p>2 connections 4 wires 2 levels</p> <p>Diode carrier 1N4007</p> <p>With voltage presence LED</p>	

(1) Blown fuse indicator 12/24/48V~ /~ Cat.No 375 24 or 110/250V~ Cat.No 375 25
(2) Lower level only

(3) Upper level only

Old range (p. 12-13) available while stocks last

	TERMINAL BLOCK				INSULATION		EQUIPOTENTIAL LINK			MEASUREMENT	ASSOCIATED PRODUCTS
	Nominal cross-section (mm ²)	Pitch (mm)	Colour	Cat.Nos	End cap	Separation and insulation divider	Comb for 2 blocks	Comb for 3 blocks	Comb for 10 blocks	Test socket	
	4	5		372 60	375 86	375 95	375 02		375 01	375 27	 End stops (p. 18) Label holder for end stop (p. 18) Handle lever mini lever (p. 19) Joining rods for disconnect blocks (p. 19) Blown fuse indicators (p. 19) Shielding (p. 19) CAB 3 (p. 27)
				372 00							
				372 20							
	4	6		372 61	built-in	375 95	375 05		375 04	375 27	
				372 01							
				372 21							
	6	8		372 62	built-in		375 08	375 07		375 27	
				372 02							
	10	10		372 63	built-in		375 82				
				372 03							
	16	12		372 64	built-in		375 85				
				372 04							
	4	5		372 40	375 87	375 95	375 02		375 01	375 27	
				372 41							
				372 42							
4	6		372 43	built-in	375 95	375 05		375 04	375 27		
			372 44								
4	5		372 46	375 88	375 95	375 02		375 01	375 27		
			372 47								
4	6		372 69	built-in		375 05		375 04	375 27		
			372 09								
4	5		372 67	375 89	375 96	375 02		375 01	375 27 ⁽³⁾		
			372 07								
4	6		372 68	built-in	375 96	375 05		375 04	375 27 ⁽³⁾		
			372 08								
4	5		372 70	375 86							
4	6		372 71	built-in							
6	8		372 72								
10	10		372 73								
16	12		372 74								
4	5		372 10	375 87							
4	6		372 11	built-in							
4	5		372 12	375 88							
4	6		372 79	built-in							
2.5	6		372 80	375 90		375 05		375 04	375 27		
			372 81	375 90		375 05		375 04			
			372 81 + 375 24/25 ⁽¹⁾								
			372 82								
			372 83	375 90		375 05		375 04	375 27		
			372 84								
			372 85								
	372 86	375 90		375 05		375 04	375 27				
4	5		372 54	375 88	375 95	375 02		375 01			
			372 55	375 89	375 96	375 02		375 01			
			372 56	375 89	375 96	375 02 ⁽²⁾		375 01 ⁽²⁾			

Viking™ 3 power terminal blocks

	ELECTRICAL FUNCTION	TERMINAL BLOCK				INSULATION Separation and insulation divider	EQUIPOTENTIAL LINK Shunt	PROTECTION		ASSOCIATED PRODUCTS CAB 3 (p. 27)
		Max. connection (mm ²)	Pitch (mm)	Cat.Nos				Cover 4 blocks	Cover 3 blocks	
				Rail	Rail					
 390 11 390 21 390 14 Power terminal blocks (p. 24)	Cable - cable		42	390 10			394 46			
			55	390 11			394 47			
	Cable lug - Cable lug		36	390 13			394 46			
			42	390 14			394 46			
	Cable lug - Cable		42	390 17			394 46			
			55	390 18			394 47			
	Cable - Cable lug		42	390 20			394 46			
			55	390 21			394 47			
	For busbars or eyelets		35	26	390 71 ⁽¹⁾	390 31	394 77		394 88	
			70	34	390 72 ⁽¹⁾	390 32	394 78		394 86	
			120	34	390 73 ⁽¹⁾	390 33	394 78		394 86	
			240	46	390 74 ⁽¹⁾	390 34	394 78		394 89 394 86	

(1) Available March 2009

old range: Viking™ 3 terminal blocks and accessories and equivalences between old/new range

Old range available while stocks last

SCREW CONNECTION

		TERMINAL BLOCKS				
		Nominal capacity (mm ²)	Pitch (mm)	Cat.Nos (old range)	Cat.Nos (new range)	
Standard	1 connection	2.5	5	390 60	371 60	
		4	6	390 61	371 61	
		6	8	390 62	371 62	
		10	10	390 64	371 63	
		16	12	390 66	371 64	
		35	15	390 68	371 65	
		70	22	390 70	371 66	
1 connection - 1 ent. - 2 out.	4	6	390 82	371 69		
	2.5	5	390 77	371 67		
	4	6	390 78	371 68		
2 connections - 2 levels	4	6	390 78	371 68		
3 connections - 3 levels	2.5	5	390 51	371 51		
V.O. - UL 94	1 connection	2.5	5	390 00	-	
		4	6	390 01	-	
		6	8	390 02	-	
		10	10	390 04	-	
		16	12	390 06	-	
Function blocks	2 connections 2 levels	Shunted	4	6	390 76	371 69
		Diode carrier	4	6	390 80	371 55
		With voltage presence LED	4	6	390 81	371 56
Disconnect	1 connection	Blade type	4	6	390 84	371 84
		Neutral equipped	4	8	390 85	371 82
		For cartridge 5 x 20	10	12	390 83	371 87
			4	8	390 86	371 81
		For cartridge 6.3 x 32	4	8	390 87 ⁽¹⁾	371 81 + 375 25
			10	12	390 89	371 88
2 connections 2 levels	For cartridge 5 x 20	4	8	390 88	-	

SCREW CONNECTION (CONTINUED)

		TERMINAL BLOCKS				
		Nominal capacity (mm ²)	Pitch (mm)	Cat.Nos (old range)	Cat.Nos (new range)	
For neutral conductor	1 connection	2.5	5	393 00	371 00	
		4	6	393 01	371 01	
		6	8	393 02	371 02	
		10	10	393 03	371 03	
		16	12	393 04	371 04	
2 connections - 2 levels	35	15	393 05	371 05		
	4	6	393 07	371 08		
For circuit not broken	1 connection	2.5	5	393 37	371 20	
		4	6	393 39	371 21	
		4	6	393 38	371 85	
For sensor/actuator	3 connections 3 levels	Sensor/power supply unit	2.5	5	390 51	371 51
		Actuator/power supply unit	2.5	5	390 52	371 52
For special circuits	1 connection	PNE	2.5	5	390 51	371 51
		1 connection - red	2.5	5	393 29	371 30
		1 connection - red	4	6	393 30	371 31
		1 connection - white	2.5	5	393 31	-
		1 connection - white	4	6	393 32	-
		1 connection - brown	2.5	5	393 33	-
		1 connection - brown	4	6	393 34	-
		1 connection - purple	2.5	5	393 35	-
1 connection - purple	4	6	393 36	-		
For protection conductor	1 connection - Metal base	2.5	5	393 70	371 70	
		4	6	393 71	371 71	
		6	8	393 72	371 72	
		10	10	393 74	371 73	
		16	12	393 76	371 74	
		35	15	393 78	371 75	
		2 connections - 2 levels - Metal base	4	6	393 73	371 79
		1 connection - Plastic base	4	6	393 81	371 77
6	8	393 82	371 78			
1 connection - Metal base - bare terminal	35	15	393 96	371 76		

(1) With blown fuse indicator (neon bulb 230 V~)

Red catalogue numbers: New products

old range: Viking™ 3 terminal blocks and accessories

and equivalences between old/new range (continued)

Available while stocks last

SPRING CONNECTION

			TERMINAL BLOCKS				
			Nominal capacity (mm ²)	Pitch (mm)	Cat.Nos (old range)	Cat.Nos (new range)	
Standard	1 connection	2 wires	2.5	5	396 01	372 60	
			4	6	396 04	372 61	
			6	8	396 05	372 62	
			10	10	396 06	372 63	
		16	12	396 07	372 64		
		2.5	5	396 02	372 40		
	3 wires 1 ent. - 2 out.	4	6	396 08	372 43		
		2.5	5	396 03	372 46		
	4 wires 1 ent. - 3 out.						
	2 connections 2 levels	4 wires	1.5	5	396 27	372 67	
			4	6	396 36	372 68	
For neutral conductor	1 connection	2 wires	2.5	5	396 11	372 00	
			4	6	396 14	372 01	
			6	8	396 15	372 02	
			10	10	396 16	372 03	
		16	12	396 17	372 04		
		2.5	5	396 12	372 41		
	3 wires 1 ent. - 2 out.	4	6	396 18	372 44		
		2.5	5	396 13	372 47		
	4 wires 1 ent. - 3 out.						
	2 connections 2 levels	4 wires	4	6	396 46	372 08	
Disconnect	1 connection	2 wires	Blade type for cartridge 5 x 20	4	6	396 28	372 84
				4	6	396 40 /41	372 81
Diode carrier	1 connection	4 wires					
For protection conductor	1 connection	2 wires	2.5	5	396 21	372 70	
			4	6	396 24	372 71	
			6	8	396 25	372 72	
			10	10	396 26	372 73	
		16	12	396 29	372 74		
		2.5	5	396 22	372 10		
	3 wires 1 ent. - 2 out.	4	6	396 30	372 11		
		2.5	5	396 23	372 12		
	4 wires 1 ent. - 3 out.						
	2 connections 2 levels	4 wires	4	6	396 66	372 79	

END STOPS

	Cat.Nos (old range)	Cat.Nos (new range)
12 pitch end stop, tri-rail	394 00	375 13
8 pitch end stop, rail □	394 02	-
8 pitch end stop, rail ▱	394 03	375 11
10 pitch high end stop	394 04	-
10 pitch end stop, bar support	393 99	375 12

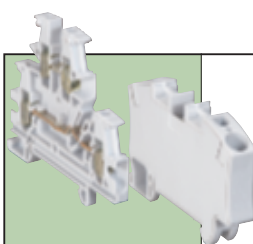

Discover the new Viking 3 terminal blocks with screw and spring connection

see p. 14

SCREW CONNECTION ACCESSORIES

Cat.Nos	End cap	Cat.Nos	Equipotential bridging comb (continued)
394 50	Block with 1 connection - pitch 5-6	394 41	Pitch 5 - 3 blocks
394 51	Block with 1 connection - pitch 8-10	394 44	Pitch 6 - 3 blocks
394 52	Block with 1 connection - pitch 12-15	394 22	Sens./act. - pitch 5 - blue - 12 blocks
394 82	Block with 1 connection 1 ent./2 out. - pitch 6	394 23	Sens./act. - pitch 5 - brown - 12 blocks
394 55	Block with 2 connections - pitch 5-6	394 26	Sens./act. - pitch 5 - green - 12 blocks
394 53	Sensor/actuator block - 3 connections Cat.Nos 390 51/52	Equipotential bridging bar	
394 73	Block with 1 connection V.O. - UL 94 - pitch 5-6	394 10	Insulated - pitch 5 - 12 blocks
394 74	Block with 1 connection V.O. - UL 94 - pitch 8-10	394 11	Insulated - pitch 6 - 12 blocks
394 75	Block with 1 connection V.O. - UL 94 - pitch 12-15	394 12	Insulated - pitch 8 - 12 blocks
393 49	Disconnect block - 1 connection Cat.Nos 390 85/86/87	394 34	Insulated - pitch 5 - 2 blocks
394 83	Disconnect block - 1 connection Cat.No 390 83	394 37	Insulated - pitch 6 - 2 blocks
393 48	Disconnect block - 2 connections Cat.No 390 88	394 35	Insulated - pitch 5 - 3 blocks
393 09	Neutral block - 1 connection - pitch 5-6	394 38	Insulated - pitch 6 - 3 blocks
393 11	Neutral block - 1 connection - pitch 8-10	394 13	Bare - pitch 10 - 12 blocks
393 13	Neutral block - 1 connection - pitch 12-15	394 14	Bare - pitch 12 - 12 blocks
393 15	Neutral block - 2 connections - pitch 5-6	394 15	Bare - pitch 15 - 12 blocks
393 46	Block for circuit not broken - 1 connection Cat.Nos 393 37/39	394 16	Bare - pitch 10 - 12 blocks - low spacer
393 45	Block for circuit not broken - 1 connection Cat.No 393 38	394 17	Bare - pitch 12 - 12 blocks - low spacer
393 84	Block for cond. protection - 2 connections Cat.No 393 73	394 18	Bare - pitch 15 - 12 blocks - low spacer
393 87	Block for cond. protection - 1 connection Cat.No 393 81	Protective screen	
393 88	Block for cond. protection - 1 connection Cat.No 393 82	394 92	Single pole for block with 1 connection - pitch 5-6
Separation/insulation divider		394 93	Single pole for block with 1 connection - pitch 8-10
394 66	Block with 1 connection pitch 5-6-8-10 and disconnect pitch 6	394 94	Single pole for block with 1 connection - pitch 12-15
394 69	Block with 2 connections pitch 5-6	394 80	Cut to length - pitch 5-6-8-10 (on Cat.No 394 66)
394 67	Block with 1 connection pitch 12-15 and disconnect pitch 8	394 81	Cut to length - pitch 12-15 (on Cat.No 394 67)
394 53	Block with 3 connections pitch 5	Miscellaneous	
394 72	Separation barriers for bars for block with 1 connection - pitch 5-6-8-10-12-15	394 05	Screening continuity bracket for 1 connection blocks - pitch 5-6-8-10
Equipotential bridging comb		394 95	Protection cap for separable combs/bars - pitch 5-6
394 31	Pitch 5 - 12 blocks	394 06	Joining rod for 2 disconnect blocks
394 20	Pitch 6 - 12 blocks	394 07	Joining rod for 3 disconnect blocks
394 21	Pitch 8 - 12 blocks	394 08	Joining rod for 4 disconnect blocks
394 40	Pitch 5 - 2 blocks	394 24	Test socket for block pitch 5-6-8-10
394 43	Pitch 6 - 2 blocks	394 25	Test socket for block pitch 12-15

SPRING CONNECTION ACCESSORIES

Cat.Nos	End cap	Cat.Nos	Separation/insulation divider
396 31	Std term. block - 2 wires - pitch 5-6	396 49	Block with 2 wires - pitch 5-6
396 32	Std term. block - 3 wires - pitch 5	396 50	Block with 3 wires - pitch 5
396 77	Std term. block - 3 wires - pitch 6	396 80	Block with 3 wires - pitch 6
396 33	Std/diode term. block - 4 wires - pitch 5	396 51	Block with 4 wires - pitch 5
396 48	Std term. block - 4 wires - 2 levels - pitch 5	396 53	Block with 4 wires - 2 levels - pitch 5
396 85	Std term. block - 4 wires - 2 levels - pitch 6	396 88	Block with 4 wires - 2 levels - pitch 6
396 37	Neutral term. block - 2 wires - pitch 5-6	Equipotential bridging comb	
396 38	Neutral term. block - 3 wires - pitch 5	396 58	Block - pitch 5 - 2 poles
396 78	Neutral term. block - 3 wires - pitch 6	396 59	Block - pitch 5 - 3 poles
396 39	Neutral term. block - 4 wires - pitch 5	396 60	Block - pitch 5 - 10 poles
396 86	Neutral term. block - 4 wires - 2 levels - pitch 6	396 61	Block - pitch 6 - 2 poles
396 47	Disconnect term. block - 2 wires - pitch 6	396 62	Block - pitch 6 - 3 poles
396 43	Protection cond. term. block - 2 wires - pitch 5-6	396 63	Block - pitch 6 - 10 poles
396 76	Protection cond. term. block - 3 wires - pitch 5	396 75	Block - pitch 8 - 2 poles
396 79	Protection cond. term. block - 3 wires - pitch 6	396 64	Block - pitch 10 - 2 poles
396 45	Protection cond. term. block - 4 wires - pitch 5	396 65	Block - pitch 12 - 2 poles
396 87	Protection cond. term. block - 4 wires - 2 levels - pitch 6		

terminal blocks with screw connection Viking™ 3 NEW

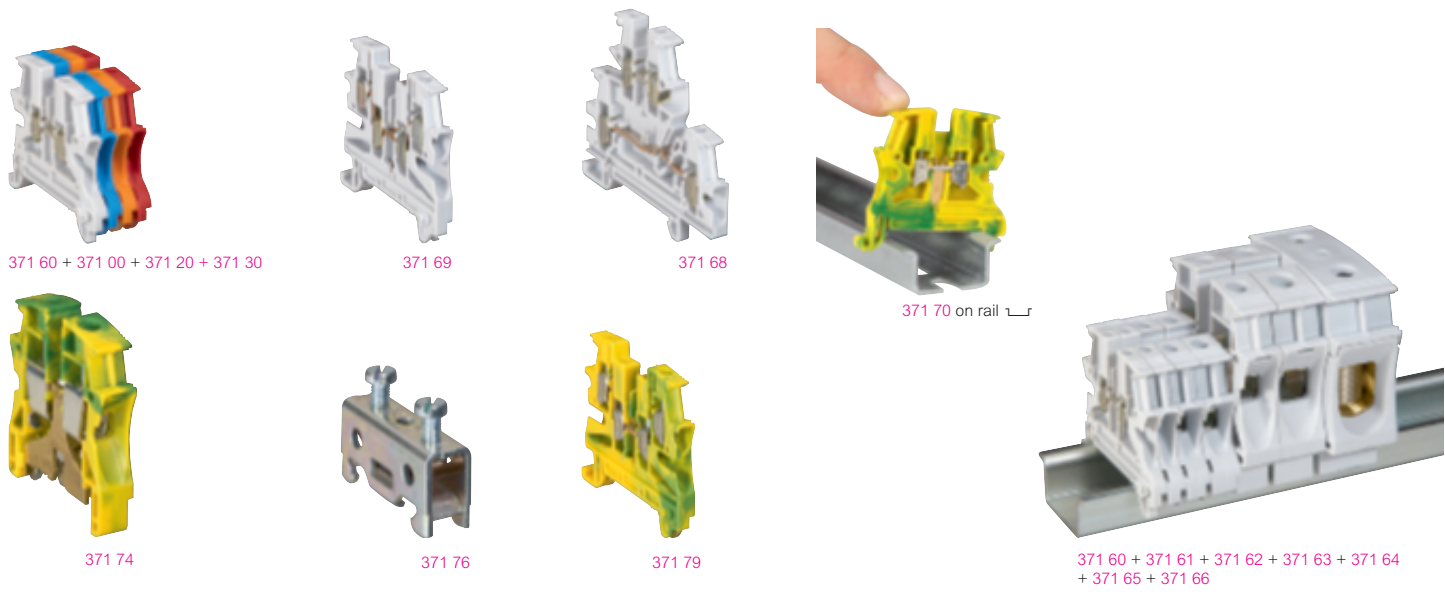

371 60 + 371 00 + 371 20 + 371 30

371 69

371 68

371 70 on rail

371 74

371 76

371 79

371 60 + 371 61 + 371 62 + 371 63 + 371 64 + 371 65 + 371 66

Technical characteristics (p. 20)

Used to make the electrical connection between 2 rigid or flexible copper wires
 2 areas for bridging combs for alternating equipotential connection up to 8 pitch
 For rails depth 15 mm, EN 60715 depth 7.5 mm and 15 mm

Pack	Cat.Nos	Connecting	Capacity			Pitch (mm)
			Nominal cross-section (mm ²)	Rigid wire (mm ²)	Flexible wire (mm ²)	
		Grey for standard circuit, blue for neutral conductor, orange for circuit not broken by the master isolating device, red for special circuits (safety, protected, etc)				
		1 connection - 1 entry/1 outlet				
60	371 60	Grey	2.5	0.25 to 4	0.25 to 2.5	5
60	371 00	Blue				
60	371 20	Orange				
60	371 30	Red				
50	371 61	Grey	4	0.25 to 6	0.25 to 4	6
50	371 01	Blue				
50	371 21	Orange				
50	371 31	Red				
40	371 62	Grey	6	0.5 to 10	0.25 to 6	8
40	371 02	Blue				
30	371 63	Grey	10	1.5 to 16	2.5 to 10	10
30	371 03	Blue				
20	371 64	Grey	16	1.5 to 25	4 to 16	12
20	371 04	Blue				
20	371 65	Grey	35	2.5 to 50	4 to 35	15
20	371 05	Blue				
10	371 66 ⁽¹⁾	Grey				
25	371 69	Grey	4	0.25 to 6	0.25 to 4	6
25	371 09	Blue				
60	371 67	Grey	2.5	0.25 to 4	0.25 to 2.5	5
60	371 07	Blue				
60	371 68	Grey	4	0.25 to 6	0.25 to 4	6
60	371 08	Blue				
50	371 51 ⁽²⁾	Grey	2.5	0.25 to 4	0.25 to 2.5	5



Pack	Cat.Nos	For protection conductor	Capacity			Pitch (mm)
			Nominal cross-section (mm ²)	Rigid wire (mm ²)	Flexible wire (mm ²)	
		1 connection - 1 entry/1 outlet - metal base				
		Screwless fixing on rail up to 10 mm pitch PEN from 10 mm ²				
60	371 70	Green/yellow	2.5	0.25 to 4	0.25 to 2.5	5
50	371 71	Green/yellow	4	0.25 to 6	0.25 to 4	6
40	371 72	Green/yellow	6	0.5 to 10	0.25 to 6	8
30	371 73	Green/yellow	10	1.5 to 16	2.5 to 10	10
10	371 74	Green/yellow	16	1.5 to 25	4 to 16	12
10	371 75	Green/yellow	35	2.5 to 50	4 to 35	15
		1 connection - bare block - metal base				
10	371 76	-	35	2.5 to 50	4 to 35	15
		1 connection - 2 entries/2 outlets - metal base				
		Screwless fixing on rail				
50	371 79	Green/yellow	4	0.25 to 6	0.25 to 4	6
		1 connection - 1 entry/1 outlet - plastic base				
		Can be used for protection conductor inside class II equivalent assemblies				
50	371 77	Green	4	0.25 to 6	0.25 to 4	6
40	371 78	Green	6	0.5 to 10	0.25 to 6	8
		PNE - Phase/Neutral/Earth				
		3 connections on 3 levels - metal base				
		Green/yellow marking for the lower level Screwless fixing on rail				
50	371 52 ⁽²⁾	Grey	2.5	0.25 to 4	0.25 to 2.5	5



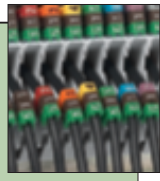

CAB 3 marking system

voir p. 27

(1) Built-in end cap
 (2) Rigid wire capacity: 2.5 mm² max. with equipotential bridging comb

Red catalogue numbers: New products

terminal blocks with screw connection Viking™ 3 (continued) NEW

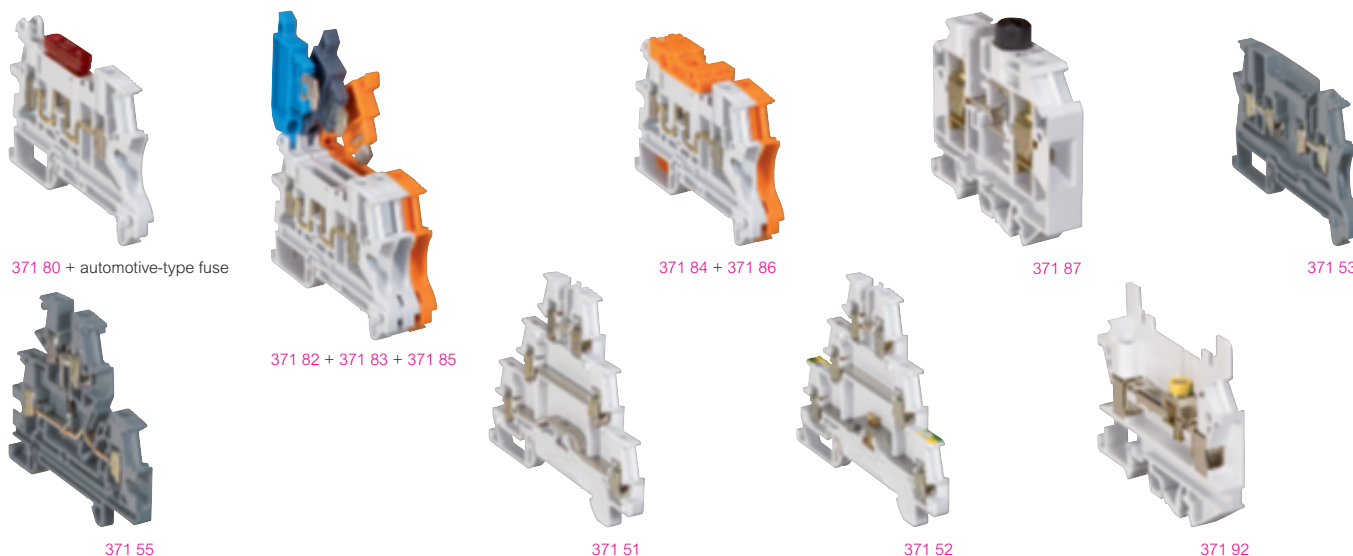

371 80 + automotive-type fuse

371 84 + 371 86

371 87

371 53

371 82 + 371 83 + 371 85

371 55

371 51

371 52

371 92

Technical characteristics (p. 20-21)

Used to make the electrical connection between 2 rigid or flexible copper wires
2 areas for bridging combs for alternating equipotential connection up to 8 pitch
For rails \perp depth 15 mm, \perp EN 60715 depth 7.5 mm and 15 mm

Pack	Cat.Nos	Disconnect terminal blocks 1 connection				
		Disconnection by means of blade type lever, handle lever or mini lever (with tool)				
		Open (to be equipped)				
		Can take a blade-type automotive fuse or a miniature circuit-breaker, or blade type levers Cat.Nos 375 15/16/17/18				
		Colour	Nominal cross-section (mm ²)	Capacity		Pitch (mm)
				Rigid wire (mm ²)	Flexible wire (mm ²)	
20	371 80	Grey	2.5	0.25 to 2.5	0.25 to 2.5	6
20	371 81	Grey	2.5	0.25 to 2.5	0.25 to 2.5	6
20	371 82	Grey/blue	2.5	0.25 to 2.5	0.25 to 2.5	6
20	371 83	Grey	2.5	0.25 to 2.5	0.25 to 2.5	6
20	371 84	Grey	2.5	0.25 to 2.5	0.25 to 2.5	6
20	371 85	Orange	2.5	0.25 to 2.5	0.25 to 2.5	6
20	371 86	Orange	2.5	0.25 to 2.5	0.25 to 2.5	6
20	371 87	Grey	10	0.25 to 16	0.25 to 10	12
20	371 88	Grey	10	0.25 to 16	0.25 to 10	12

Blade type levers, joining rods and blown fuse indicators (p. 19)



Pack	Cat.Nos	Function blocks				
		1 connection - modular				
		Component connected with screws				
		Colour	Nominal cross-section (mm ²)	Capacity		Pitch (mm)
				Rigid wire (mm ²)	Flexible wire (mm ²)	
20	371 53	Grey	2.5	0.25 to 4	0.25 to 2.5	5
20	371 54	Grey	2.5	0.25 to 4	0.25 to 2.5	5
60	371 55	Grey	4	0.25 to 6	0.25 to 4	6
60	371 56	Grey	4	0.25 to 6	0.25 to 4	6
		For sensors and actuators				
		For connecting sensors (Cat.No 371 51) or actuators (Cat.No 371 52), and their shared power supply unit using equipotential bridging comb Cat.Nos 375 46/47 (wiring principle p. 21)				
		3 connections on 3 levels - for sensor				
		Colour	Nominal cross-section (mm ²)	Capacity		Pitch (mm)
				Rigid wire (mm ²)	Flexible wire (mm ²)	
50	371 51 ⁽¹⁾	Grey	2.5	0.25 to 4	0.25 to 2.5	5
		3 connections on 3 levels - for actuator				
		Green/yellow marking for the lower level Metal base. Screwless fixing on rail				
50	371 52 ⁽¹⁾	Grey	2.5	0.25 to 4	0.25 to 2.5	5
		Disconnect for measurement				
		1 connection				
		With its accessories, allows intervention (measurements, maintenance, etc) on a current, voltage and power measuring circuit by keeping the current transformer secondary circuit closed				
		Colour	Nominal cross-section (mm ²)	Capacity		Pitch (mm)
				Rigid wire (mm ²)	Flexible wire (mm ²)	
25	371 92	Grey	4	0.25 to 4	0.25 to 4	8

Accessories (p. 18)

End stops (p. 18)

(1) Rigid wire capacity: 2.5 mm² max with equipotential bridging comb

terminal blocks with spring connection Viking™ 3 NEW



372 60 + 372 00 + 372 20



372 01



372 21



372 63



372 40

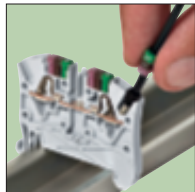

Automatic insertion of flexible wire with ferrule cap or rigid wire up to pitch of 6 mm

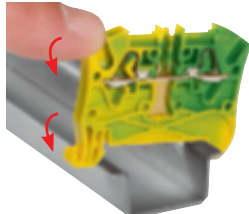

372 70 Automatic fixing on rail



372 72



372 79

Technical characteristics (p. 22)

Screwless connection system, stainless steel spring type
 Used to make the electrical connection between 2 rigid copper wires, or flexible copper wires with or without ferrules (p. 30)
 Direct tool-free insertion of a rigid wire or flexible wire with ferrule, up to 6 mm pitch
 2 areas for bridging combs for alternating equipotential connection
 For rails \perp depth 15 mm, \perp EN 60715 depth 7.5 mm and 15 mm

Pack	Cat.Nos	Connecting	Capacity				Pitch (mm)
		Grey for standard circuit, blue for neutral conductor, orange for circuit not broken by the master isolating device					
1 connection - 2 wires - 1 entry/1 outlet							
60	372 60	Grey	4	0.5 to 6	0.5 to 4	0.5 to 2.5	5
60	372 00	Blue	4	0.5 to 6	0.5 to 4	0.5 to 4	6
60	372 20	Orange	4	0.5 to 6	0.5 to 4	0.5 to 4	6
50	372 61 ⁽¹⁾	Grey	4	0.5 to 6	0.5 to 4	0.5 to 4	6
50	372 01 ⁽¹⁾	Blue	4	0.5 to 6	0.5 to 4	0.5 to 4	6
50	372 21 ⁽¹⁾	Orange	4	0.5 to 6	0.5 to 4	0.5 to 4	6
50	372 62 ⁽¹⁾	Grey	6	0.5 to 6	0.5 to 6	0.5 to 6	8
50	372 02 ⁽¹⁾	Blue	6	0.5 to 6	0.5 to 6	0.5 to 6	8
40	372 63 ⁽¹⁾	Grey	10	0.75 to 10	0.75 to 10	0.75 to 10	10
40	372 03 ⁽¹⁾	Blue	10	0.75 to 10	0.75 to 10	0.75 to 10	10
10	372 64 ⁽¹⁾	Grey	16	4 to 16	4 to 16	4 to 16	12
10	372 04 ⁽¹⁾	Blue	16	4 to 16	4 to 16	4 to 16	12
1 connection - 3 wires - 1 entry/2 outlets							
60	372 40	Grey	4	0.5 to 6	0.5 to 4	0.5 to 2.5	5
60	372 41	Blue	4	0.5 to 6	0.5 to 4	0.5 to 2.5	5
60	372 42	Orange	4	0.5 to 6	0.5 to 4	0.5 to 2.5	5
50	372 43 ⁽¹⁾	Grey	4	0.5 to 6	0.5 to 4	0.5 to 4	6
50	372 44 ⁽¹⁾	Blue	4	0.5 to 6	0.5 to 4	0.5 to 4	6
1 connection - 4 wires - 2 entries/2 outlets							
60	372 46	Grey	4	0.5 to 6	0.5 to 4	0.5 to 2.5	5
60	372 47	Blue	4	0.5 to 6	0.5 to 4	0.5 to 2.5	5
50	372 69 ⁽¹⁾	Grey	4	0.5 to 6	0.5 to 4	0.5 to 4	6
50	372 09 ⁽¹⁾	Blue	4	0.5 to 6	0.5 to 4	0.5 to 4	6
2 connections - 4 wires - 2 levels							
60	372 67	Grey	4	0.5 to 6	0.5 to 4	0.5 to 2.5	5
60	372 07	Blue	4	0.5 to 6	0.5 to 4	0.5 to 2.5	5
50	372 68 ⁽¹⁾	Grey	4	0.5 to 6	0.5 to 4	0.5 to 4	6
50	372 08 ⁽¹⁾	Blue	4	0.5 to 6	0.5 to 4	0.5 to 4	6

Pack	Cat.Nos	For protection conductor	Capacity				Pitch (mm)
		Metal base Screwless fixing on rail PEN from 10 mm ²					
1 connection - 2 wires - 1 entry/1 outlet							
60	372 70	Green/yellow	4	0.5 to 6	0.5 to 4	0.5 to 2.5	5
50	372 71 ⁽¹⁾	Green/yellow	4	0.5 to 6	0.5 to 4	0.5 to 4	6
25	372 72 ⁽¹⁾	Green/yellow	6	0.5 to 6	0.5 to 6	0.5 to 6	8
20	372 73 ⁽¹⁾	Green/yellow	10	0.75 to 10	0.75 to 10	0.75 to 10	10
15	372 74 ⁽¹⁾	Green/yellow	16	4 to 16	4 to 16	4 to 16	12
1 connection - 3 wires - 1 entry/2 outlets							
40	372 10	Green/yellow	4	0.5 to 6	0.5 to 4	0.5 to 2.5	5
30	372 11 ⁽¹⁾	Green/yellow	4	0.5 to 6	0.5 to 4	0.5 to 4	6
1 connection - 4 wires - 2 entries/2 outlets							
40	372 12	Green/yellow	4	0.5 to 6	0.5 to 4	0.5 to 2.5	5
30	372 79 ⁽¹⁾	Green/yellow	4	0.5 to 6	0.5 to 4	0.5 to 4	6

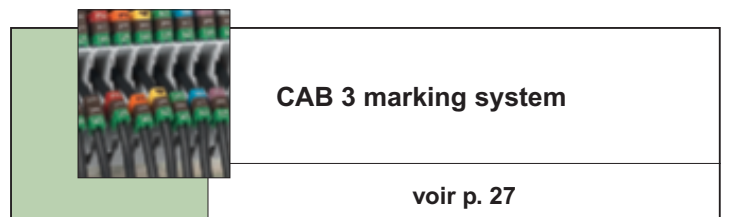

(1) Built-in end cap

terminal blocks with spring connection Viking™ 3 (continued) NEW

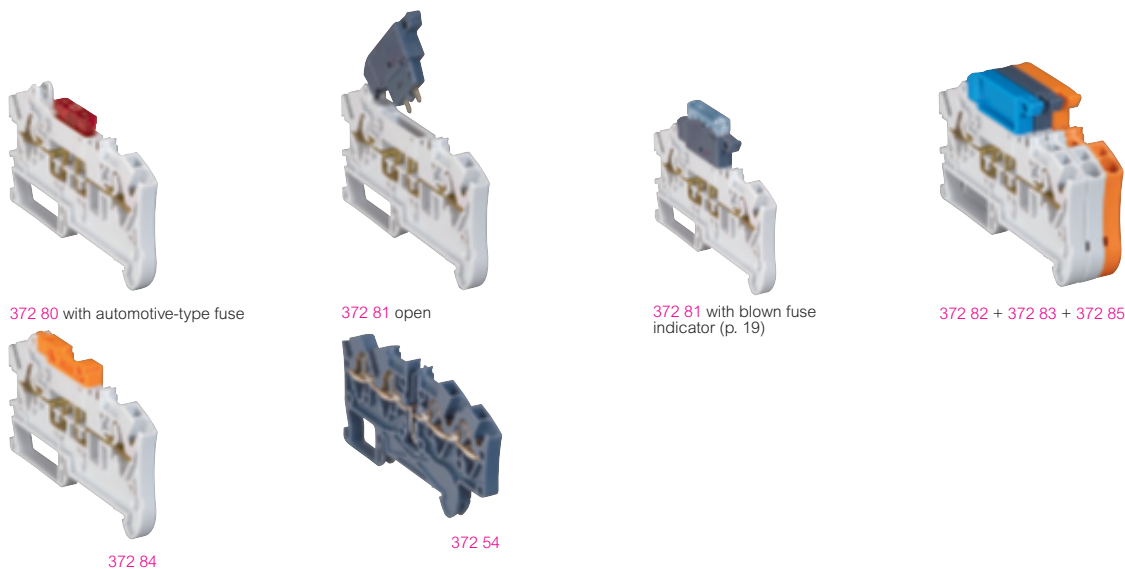

Technical characteristics (p. 22)

Screwless connection system, stainless steel spring type
 Used to make the electrical connection between 2 rigid copper wires, or flexible copper wires with or without ferrules (p. 30)
 Direct tool-free insertion of a rigid wire or flexible wire with ferrule, up to 6 mm pitch
 2 areas for bridging combs for alternating equipotential connection
 For rails depth 15 mm, EN 60715 depth 7.5 mm and 15 mm

Pack	Cat.Nos	Disconnect terminal blocks 1 connection - 2 wires					
		Disconnection by means of blade type lever, handle lever or mini lever (with tool)					
		Open (to be equipped)					
		Can take a blade-type automotive fuse or a miniature circuit-breaker, or blade type levers Cat.Nos 375 15/16/17/18					
			Nominal cross-section (mm ²)	Capacity		Pitch (mm)	
		Colour	Rigid wire (mm ²)	Flexible wire (mm ²)	Flexible wire with ferrule (mm ²)		
20	372 80	Grey	2.5	0.5 to 2.5	0.5 to 2.5	0.5 to 2.5	6
20	372 81	Grey	2.5	0.5 to 2.5	0.5 to 2.5	0.5 to 2.5	6
20	372 82	Grey/blue	2.5	0.5 to 2.5	0.5 to 2.5	0.5 to 2.5	6
20	372 83	Grey	2.5	0.5 to 2.5	0.5 to 2.5	0.5 to 2.5	6
20	372 84	Grey	2.5	0.5 to 2.5	0.5 to 2.5	0.5 to 2.5	6
20	372 85	Orange	2.5	0.5 to 2.5	0.5 to 2.5	0.5 to 2.5	6
20	372 86	Orange	2.5	0.5 to 2.5	0.5 to 2.5	0.5 to 2.5	6

Blade type levers, joining rods and blown fuse indicators (p. 19)

Pack	Cat.Nos	Function blocks					
		1 connection - 4 wires - 2 entries/2 outlets - diode carrier					
		Colour	Nominal cross-section (mm ²)	Rigid wire (mm ²)	Capacity		
					Flexible wire (mm ²)	Flexible wire with ferrule (mm ²)	Pitch (mm)
60	372 54	Grey	4	0.5 to 6	0.5 to 4	0.5 to 2.5	5
60	372 55	Grey	4	0.5 to 6	0.5 to 4	0.5 to 2.5	5
60	372 56	2 connections - 4 wires - 2 levels - diode carrier					
		2 connections - 4 wires - 2 levels - with LED					
		Voltage presence indicator (12/24V _{DC} et \sim)					
		Grey	4	0.5 to 6	0.5 to 4	0.5 to 2.5	5

Accessories (p. 18)

End stops (p. 18)



New Starfix crimping tools

voir p. 30

accessories for terminal blocks Viking™ 3

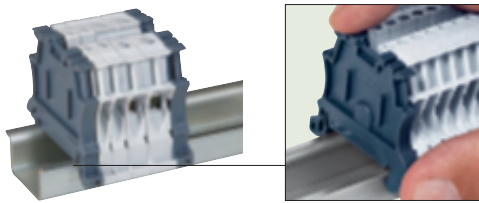

End stop 375 10, screwless mounting

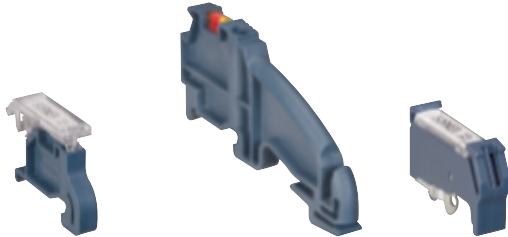

375 11 with label holder 395 96

375 12 with CAB 3 labelling

375 13 with label holder Duplix 384 98

Technical characteristics (p. 23)

Pack	Cat.Nos	Rails for cutting to length
10	374 04	Length 2 m ┌ EN 60715 depth 7.5 mm
10	374 07	└ depth 15 mm
10	477 22	┌ depth 7.5 mm with oblong holes
10	477 23	└ depth 15 mm with oblong holes
45° mounting bracket		
10	394 49	Set of 2 supports for tilting a rail at an angle of 45° Supplied with 4 x M6 screws, nuts and washers
End stops		
Accept CAB 3 markers		
50	375 10	Automatic 6 mm pitch Screwless mounting For rails ┌ depth 15 mm and ┌ EN 60715 depth 7.5 mm and 15 mm Accepts label holder Cat.No 395 96 Acts as end cap for screw terminal blocks 1 entry/1 outlet 5, 6, 8 and 10 mm pitch
20	375 11	8 mm pitch For rails ┌ depth 15 mm and ┌ EN 60715 depth 7.5 mm and 15 mm Accepts label holder Cat.No 395 96
10	375 12	10 mm pitch For rails ┌ depth 15 mm and ┌ EN 60715 depth 7.5 mm (except for rail fixed on plate) and 15 mm For supporting protection or shielding bar: - Brass bar Cat.Nos 373 00/01 - Copper bar 12 x 4 mm with clamps Cat.No 373 02 - IP 2X terminal block with flat steel bar 12 x 2 mm Cat.No 048 19 - Copper bar 12 x 4 mm Cat.No 373 49 or 373 89 - Shielding bar 10 x 3 mm Cat.No 375 34
20	375 13	12 mm pitch For rails ┌ EN 60715, ┌ depth 15 mm and ┌ EN 60715 depth 7.5 mm and 15 mm After cutting out the upper divider, can be labelled using Duplix label holder Cat.No 384 98
Identification accessories		
20	395 96	Transparent label holder with variable angle Fixing on end stops Cat.Nos 375 10/11 Supplied with label 32 x 9.5 mm Can take label Cat.No 395 97
20	395 97	Label for engraving 28 x 9.5 mm For label holder Cat. No 395 96. Flexible ABS
10	395 98	White background, black engraving Black felt tip pen for permanent marking

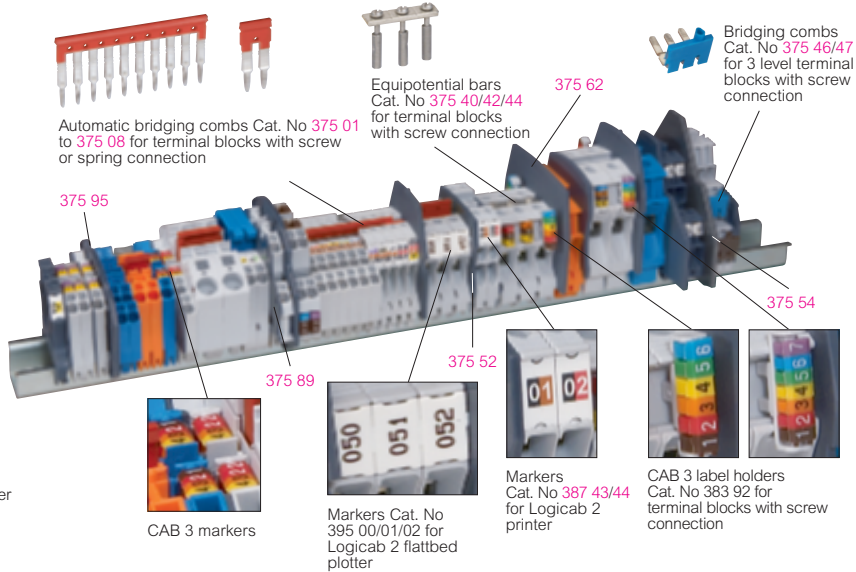

Automatic bridging combs Cat. No 375 01 to 375 08 for terminal blocks with screw or spring connection

Equipotential bars Cat. No 375 40/42/44 for terminal blocks with screw connection

Bridging combs Cat. No 375 46/47 for 3 level terminal blocks with screw connection

CAB 3 markers

Markers Cat. No 395 00/01/02 for Logicab 2 flatbed plotter

Markers Cat. No 387 43/44 for Logicab 2 printer

CAB 3 label holders Cat. No 383 92 for terminal blocks with screw connection

Pack	Cat.Nos	End caps
Grey		
100	375 50	For screw terminal blocks 1 entry/1 outlet 5, 6, 8 and 10 mm pitch
20	375 51	1 entry/1 outlet 12 and 15 mm pitch
20	375 52	2 entries/2 outlets
20	375 53	2 levels
20	375 54	3 levels
20	375 55	Disconnect type 6 mm pitch and function blocks 5 mm pitch
20	375 56	Disconnect type fuse cartridge 5 x 20 and 6.3 x 32 with screwed plug
10	375 57	Disconnect for measurement
For spring terminal blocks with 5 mm pitch		
Allows the block to become 6 mm pitch and take a flexible wire fitted with a ferrule 4 mm ²		
50	375 86	1 entry/1 outlet
50	375 87	1 entry/2 outlets
20	375 88	2 entries/2 outlets
20	375 89	2 levels
20	375 90	For spring terminal blocks with 6 mm pitch Disconnect type
Separation and insulation dividers		
Grey		
20	375 60	For screw terminal blocks 1 entry/1 outlet 5, 6, 8 and 10 mm pitch
10	375 61	1 entry/1 outlet 12 and 15 mm pitch
10	375 62	2 entries/2 outlets and disconnect type 6 mm pitch
10	375 63	2 levels
20	375 64	3 levels
10	375 95	For spring terminal blocks 1 entry/1 outlet, 1 entry/2 outlets and 2 entries/2 outlets 5 and 6 mm pitch
10	375 96	2 levels
Equipotential bridging accessories		
Bridging combs for screw and spring terminal blocks Front mounting (automatic insertion), screwless Isolated and separable. Consecutive or alternating connection. Red		
20	375 01 ⁽¹⁾	For 10 blocks with 5 mm pitch
50	375 02 ⁽¹⁾	For 2 blocks with 5 mm pitch
20	375 04 ⁽²⁾	For 10 blocks with 6 mm pitch
50	375 05 ⁽²⁾	For 2 blocks with 6 mm pitch
20	375 07 ⁽³⁾	For 3 blocks with 8 mm pitch
20	375 08 ⁽³⁾	For 2 blocks with 8 mm pitch

(1) Blocks Cat. Nos 371 51/52: upper level only
Block Cat.No 372 56: lower level only
(2) Block Cat.No 371 56: lower level only
(3) Except for Cat.No 371 92

Red catalogue numbers: New products

accessories for terminal blocks Viking™ 3 (continued)

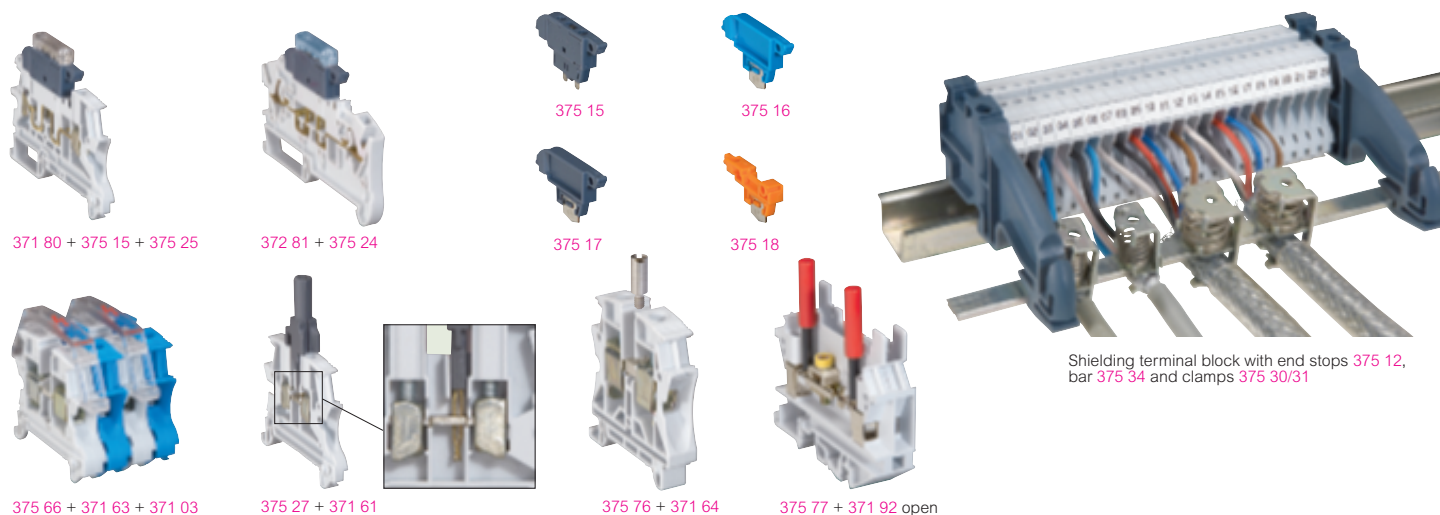

Technical characteristics (p. 22)

Equipotential bridging accessories (continued)

Emb.	Réf.	Description
		Bars for screw terminal blocks Front mounting with screws. Pre-assembled, bar Consecutive or alternating connection
10	375 40	For 12 blocks with 10 mm pitch
10	375 42 ⁽¹⁾	For 12 blocks with 12 mm pitch
10	375 44	For 12 blocks with 15 mm pitch
		Bridging combs for 3-level screw terminal blocks For lower and intermediate levels of blocks Cat.Nos 371 51/52. Side mounting Isolated and separable
10	375 46	Brown. For 12 blocks with 5 mm pitch
10	375 47	Blue. For 12 blocks with 5 mm pitch
		Bridging combs for spring terminal blocks Front mounting (automatic insertion), screwless Isolated. Red
20	375 82	For 2 blocks with 10 mm pitch
20	375 85	For 2 blocks with 12 mm pitch

Accessories for disconnect blocks

Emb.	Réf.	Description
		For screw and spring terminal blocks
		Blade type levers For open blocks Cat. Nos 371 80 and 372 80 Manual disconnection for handle type, tool required for mini lever type
10/50	375 15	With handle lever for fuse cartridge 5 x 20
10/50	375 16	Blue handle lever for neutral
10/50	375 17	Grey handle lever
10/50	375 18	Mini lever
		Joining rods For handle and mini lever
20	375 21	For 2 blocks
20	375 22	For 3 blocks
		Blown fuse indicators Clip directly onto blocks Cat.Nos 371 81, 372 81 or handle lever 375 15 (with power off)
10/50	375 24	12/24/48 V _~ and ~ for block with fuse cartridge 5 x 20 with handle lever
10/50	375 25	110/250 V _~ for block with fuse cartridge 5 x 20 with handle lever

Shielding accessories

Emb.	Réf.	Description
		Ensure safe, simple connection of cable shielding
		Shielding clamps For screw and spring terminal blocks - mounted by pivoting on collector bar 10 x 3 mm Cat.No 375 34 - mounted on plate with M4 screws (supplied) - mounted on rail with Cat.No 364 69
10	375 30	For cable diam. 3 to 8 mm
10	375 31	For cable diam. 4 to 13.5 mm
4	375 32	For cable diam. 10 to 20 mm

Shielding accessories (continued)

Emb.	Réf.	Description
		Ensure safe, simple connection of cable shielding
		Shielding bar For screw and spring terminal blocks. Steel. Length 1 m. For use with end stops Cat.No 375 12 10 x 3 mm
10	375 34	
		Screening continuity bracket For screw terminal blocks 1 entry/1 outlet 5, 6, 8 and 10 mm pitch Connected with 2.8 x 0.8 mm clips or welded on. Capacity: 1 mm ²
50	375 35	
		Protective screens
		1 pole For screw terminal blocks 1 entry/1 outlet 5 and 6 mm pitch 8 and 10 mm pitch 12 and 15 mm pitch
10	375 65	
10	375 66	
10	375 67	
		Cut to length Length 1 m Mounted on separation and insulation divider For screw terminal blocks 1 entry/1 outlet 5, 6, 8 and 10 mm pitch (divider Cat.No 375 60) 12 and 15 mm pitch (divider Cat.No 375 61)
10	375 68	
10	375 69	

Measurement accessories

Emb.	Réf.	Description
		For screw and spring terminal blocks Measurement socket for Ø4 mm plug for blocks with 5 and 6 mm pitch
10	375 27 ⁽²⁾	
		For screw terminal blocks Measurement socket for Ø2 mm plug for blocks with 10 mm pitch Cat.Nos 371 03/63 Measurement socket for Ø4 mm plug for blocks with 12 and 15 mm pitch Cat.Nos 371 04/05/64/65
50	375 75	
20	375 76	
		Measurement socket for Ø4 mm plug for disconnect block for measurement Cat.No 371 92
10	375 77	

Emb.	Réf.	Description
		IP 2X safety tip adaptor Ø2 mm test plug - Retractable tube For performing ad-hoc tests in accordance with regulations on the protection of workers Fixes directly on the Ø4 mm plug
1/10	394 45	

(1) Except for Cat.No 371 87
(2) Except for disconnect blocks with handle lever, screw terminal block with LED and spring function blocks. 2 and 3-level terminal blocks: upper level only

terminal blocks with screw connection Viking™ 3

Characteristics and dimensions (mm)

V2 polyamide according to UL 94, 960°C according to IEC EN 60695-2-11

Connecting blocks

Cat.Nos	Voltage (V)			Current (A)				Nominal cross-section		
	IEC	CSA	UL	1e	IEC	CSA	UL	IEC (mm ²)	CSA (AWG)	UL (AWG)
371 00/20/30/60	800	600	600	27	24	20	20	2.5	12	12
371 01/21/31/61				36	32	30	30	4	10	10
371 02/62				48	41	50	50	6	8	8
371 03/63				63	57	60	60	10	6	6
371 04/64				85	76	85	85	16	4	4
371 05/65				138	125	115	115	35	2	2
371 07/67				27	24	20	20	2.5	12	12
371 08/68				36	32	30	30	4	10	10
371 09/69				36	32	30	30	4	10	10
371 66				1000	600	600	213	192	200	200
371 77	800	600	600	36	32	30	30	4	10	10
371 78				48	41	50	50	6	8	8

Cat.No 371 51: see blocks for sensors
IEC 60947-7-1, CSA no. 22-2 no. 158, UL 1059
Ie: Rated current NF C 15100 table 52H, column 4

Cat.Nos 371 00/01/02/
03/20/21/30/31/60/61/
62/63/77/78

Cat.Nos
371 04/05/64/65

Cat.No 371 66

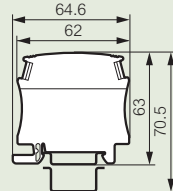
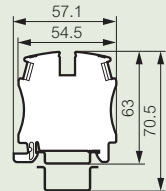
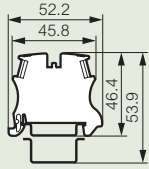

Cat.Nos 371 09/69

Cat.Nos 371 07/08/67/68

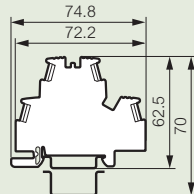
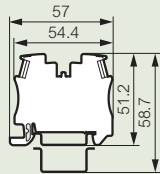

Approved by ATEX:
LCIE 07 ATEX 0010 U-0081 Ex II 1 or 2 G or D Ex e/i/tD/iD II

The terminal blocks with screw connection covered by this certificate are 1-, 2- and 3-level connecting terminal blocks, and blocks for protection conductor with metal⁽¹⁾ and plastic base (detailed list on p. 8)

The main characteristics are:
Operating temperature: - 30°C to + 55°C
Maximum temperature of materials: + 85°C

Working voltage acc. to EN 60079-7: 1-level terminal blocks: 500 V
Blocks with 2 entries - 2 outlets: 250 V
2 and 3-level terminal blocks: 250 V

Rated current:

Conductor cross-section (mm ²)	2.5	4	6	10	16	35	70
Rated current (A)	18	23	30	42	57	93	144

Attestation of conformity of component for the customer is available on request

(1) Except for Cat.No 371 76

Blocks for protection conductor

Cat.Nos	Voltage (V)			Current (A)			Nominal cross-section		
	IEC	CSA	UL	1e	IEC	UL	IEC (mm ²)	CSA (AWG)	UL (AWG)
371 70	800	600	600	-	-	-	2.5	12	12
371 71				-	-	-	4	10	10
371 72				-	-	-	6	8	8
371 73 ⁽¹⁾				63	57	10	6	6	6
371 74 ⁽¹⁾				85	76	16	4	4	4
371 75 ⁽¹⁾				138	125	35	2	2	2
371 76	-	-	-	-	-	-	35	-	-
371 77	800	600	600	36	32	4	10	10	10
371 78				48	41	6	8	8	
371 79	500	300	300	-	-	-	4	10	10

IEC 60947-7-1/7-2, CSA no. 22-2 no. 158, UL 1059
Ie: Rated current NF C 15100 table 52H, column 4
(1) PEN terminal blocks

Cat.Nos

371 70/71/72/73

Cat.Nos 371 74/75

Cat.No 371 76

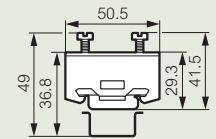
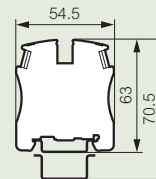
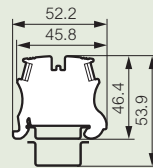

Cat.Nos 371 77/78

Cat.No 371 79

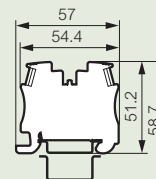
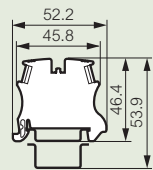

Disconnect terminal blocks

Cat.Nos	Voltage (V)			Current (A)			Nominal cross-section		
	IEC	CSA	UL	IEC	CSA	UL	IEC (mm ²)	CSA (AWG)	UL (AWG)
371 80	500	300	300	15	15	15	2.5	12	12
371 81 ou 371 80 + 375 15	250	250	250	6.3	6.3	6.3			
371 82	500	300	300	15	15	15			
371 83									
371 84									
371 85									
371 86	250	250	250	10	10	10	10		
371 87/88									

IEC 60947-7-1/7-3, CSA no. 22-2 no. 158, UL 1059

Power according to EN 60947-7-3

Cat.Nos	Short-circuit		Short-circuit + overload	
	Separate blocks	Assembled blocks	Separate blocks	Assembled blocks
371 81 or 371 80 + 375 15 ⁽¹⁾	4 W / 6.3 A Pvk = 4.75 W	1.6 W/6.3 A Pvk = 2 W	1.6 W/6.3 A Pv = 1.65 W	-
371 87/88	4 W Pvk = 5 W	2.5 W Pvk = 2.7 W	1.6 W Pv = 1.8 W	-

(1): With or without blown fuse indicator Cat.No 375 25

Cat.No 371 80

Cat.Nos 371 81/82/83/85

Cat.Nos 371 84/86

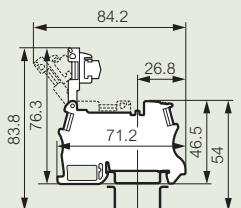
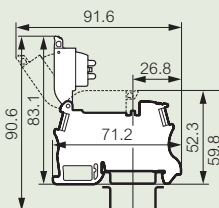
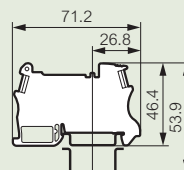

Cat.No 371 87/88

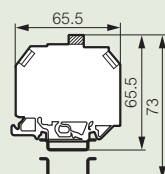

Function blocks

Cat.Nos	Voltage (V)			Current (A)			Nominal cross-section		
	IEC	CSA	UL	IEC	CSA	UL	IEC (mm ²)	CSA (AWG)	UL (AWG)
371 53	250	-	-	-	-	-	2.5	-	-
371 54	250	-	-	1	-	-	2.5	-	-
371 55	500	300	300	1	1	1	4	10	10
371 56	12 to 24	12 to 24	12 to 24	32	30	30	4	10	10

IEC 60947-7-1, CSA no. 22-2 no. 158, UL 1059

Cat.Nos 371 53/54

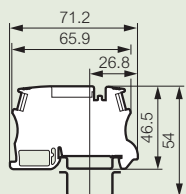

Cat.Nos 371 55/56

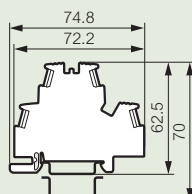

Schematic diagrams

Cat.No 371 53

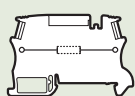

Cat.No 371 54

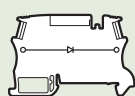

Cat.No 371 55

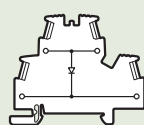

Cat.No 371 56

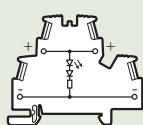

Diode for Cat.Nos 371 54/55
 - 1N4007 type 1A
 - direct current = 1 A
 - peak inverse voltage 1000 V
 - inverse current 5 µA at 25°C

Blocks for sensors and actuators/PNE

Cat.Nos	Voltage (V)			Current (A)			Nominal cross-section			
	IEC	CSA	UL	I _e	IEC	CSA	UL	IEC (mm ²)	CSA (AWG)	UL (AWG)
371 51 371 52	400	300	300	27	24	20	20	2.5	12	12

IEC 60947-7-1/7-2, CSA no. 22-2 no. 158, UL 1059
 I_e: Rated current NF C 15100 table 52H, column 4

Cat.Nos 371 51/52

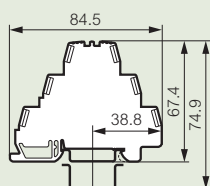

Wiring principle

Block for sensor Cat.No 371 51

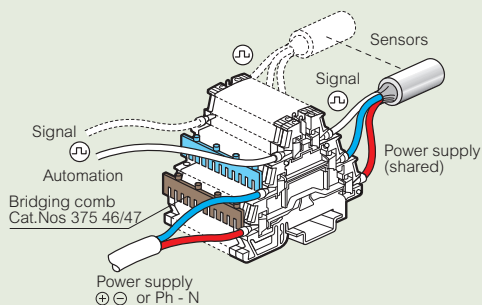

Block for actuator Cat.No 371 52

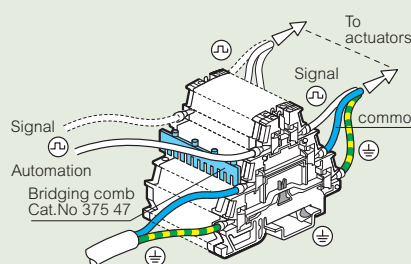

PNE block Cat.No 371 52

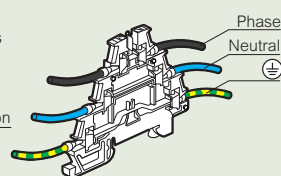

Disconnect block for measurement

Cat.Nos	Voltage (V)			Current (A)			Nominal cross-section		
	IEC	CSA	UL	IEC	CSA	UL	IEC (mm ²)	CSA (AWG)	UL (AWG)
371 92	800	-	-	24	-	-	4	-	-

IEC EN 60947-7-1

Cat.No 371 92

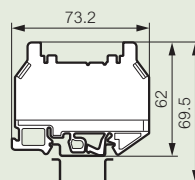

Wiring principle for measurement blocks Cat.No 371 92

Ammeter circuit

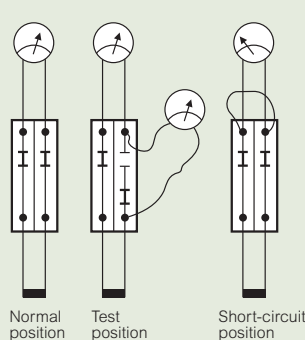

Per circuit:
 2 x Disconnect blocks for measurement Cat.No 371 92
 4 x Measurement sockets for Ø4 mm plug Cat.No 375 77
 1 x End cap Cat.No 375 57
 1 x Shunt with Ø4 mm plugs

Wattmeter circuit

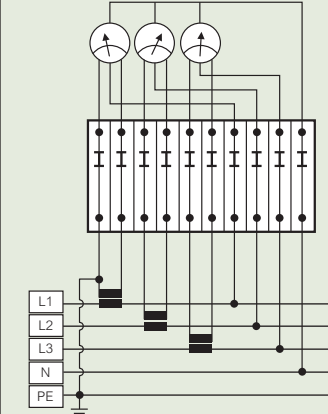

10 x Disconnect blocks for measurement Cat.No 371 92
 12 x Measurement sockets for Ø4 mm plug Cat.No 375 77
 1 x End cap Cat.No 375 57
 3 x Shunts with Ø4 mm plugs

Stripped lengths (mm)

Screw terminal pitch (mm)	Rigid or flexible wire
5	6 to 8
6	
8	10 to 12
10	
12	13 to 17
15	14 to 18
22	15 to 22

Protection against fire and panic risks in public buildings/UTE C 12-201 guide

Art. EL 3, definitions: "Security installations are those that have to be put into or maintained in service to ensure the evacuation of the public or facilitate the intervention of the first-aid"

Art. EL 16, power supply circuits in security installations section 1a: "...the corresponding junction or deviation devices and their enclosures, except for the waterproofing systems, must satisfy the incandescent wire test defined in the standard in force, the temperature of the incandescent wire being 960 °C"

Viking 3 terminal blocks satisfy the incandescent wire test 960 °C according to standard IEC 60695-2-11

terminal blocks with spring connection Viking™ 3

Characteristics and dimensions (mm)

V2 polyamide according to UL 94, 960°C according to IEC EN 60695-2-11

Connecting blocks

Cat.Nos	Voltage (V)			Current (A)				Nominal cross-section		
	IEC	CSA	UL	Ie	IEC	CSA	UL	IEC (mm²)	CSA (AWG)	UL (AWG)
372 00	800	600	600	36	32	20	20	4	12	12
372 01				48	41	30	30	6	10	10
372 02				63	57	50	50	10	8	8
372 03				85	76	65	65	16	6	6
372 04				30	30	10	10			
372 07	800	600	600	36	32	20	20	4	12	12
372 08										
372 09										
372 20										
372 21										
372 40										
372 41										
372 42										
372 43										
372 44										
372 46	500	300	300	36	32	30	30	4	10	10
372 60										
372 61										
372 62										
372 63										
372 64	800	600	600	48	41	30	30	6	10	10
372 67										
372 68										
372 69	800	600	600	20	20	12	12			

IEC 60947-7-1, CSA no. 22-2 no. 158, UL 1059
Ie: Rated current NF C 15100 table 52H, column 4

Blocks for protection conductor

Cat.Nos	Voltage (V)			Nominal cross-section		
	IEC	CSA	UL	IEC (mm²)	CSA (AWG)	UL (AWG)
372 10	800	600	600	4	10	10
372 11						
372 12						
372 70						
372 71						
372 72						
372 73 ⁽¹⁾						
372 74 ⁽¹⁾						
372 75						
372 79						

IEC 60947-7-2, CSA no. 22-2 no. 158, UL 1059
(1): PEN terminal blocks

Function blocks

Cat.Nos	Voltage (V)			Current (A)			Nominal cross-section		
	IEC	CSA	UL	IEC	CSA	UL	IEC (mm²)	CSA (AWG)	UL (AWG)
372 54	500	300	300	1	1	1	4	14	14
372 55									
372 56									

IEC 60947-7-1, CSA no. 22-2 no. 158, UL 1059

Cat.Nos 372 00/01/20/
21/60/61/70/71

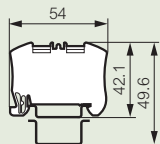

Cat.Nos 372 02/62/72

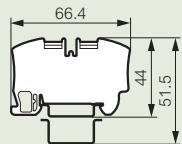

Cat.Nos 372 03/63/73

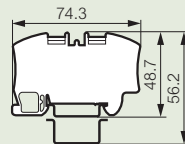

Cat.Nos 372 04/64/74

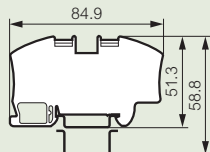

Cat.Nos 372 10/11/40/
41/42/43/44

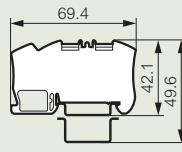

Cat.Nos 372 09/12/46/
47/54/69/79

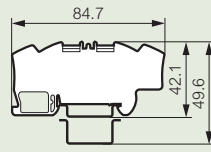

Cat.Nos 372 07/08/55/56/67/68

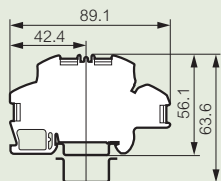

Schematic diagrams

Cat.No 372 54

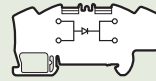

Cat.No 372 55

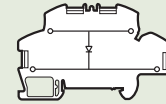

Cat.No 372 56

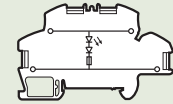

Diode for Cat.Nos 372 54/55

- 1N4007 type 1A
- direct current = 1 A
- peak inverse voltage 1000 V
- inverse current 5 µA at 25°C

Approved by ATEX:

LCIE 07 ATEX 0010 U-0081 II 1 or 2 G or D Ex e/i/tD/iD II

The terminal blocks with spring connection covered by this certificate are 1- and 2-level connecting terminal blocks, and blocks for protection conductor with metal base (detailed list on p. 10)

- The main characteristics are:
- Operating temperature: - 30°C to + 55°C
 - Maximum temperature of materials: + 85°C

Working voltage acc. to EN 60079-7: 1-level terminal blocks: 500 V
Blocks with 2 entries - 2 outlets: 500 V
2-level terminal blocks: 250 V

Rated current:

Conductor cross-section (mm²)	4	6	10	16
Rated current (A)	23	30	42	57

Attestation of conformity of component for the customer is available on request

Disconnect blocks

Cat.Nos	Voltage (V)			Current (A)			Nominal cross-section		
	IEC	CSA	UL	IEC	CSA	UL	IEC (mm²)	CSA (AWG)	UL (AWG)
372 80	500	300	300	15	15	15	2.5	14	14
372 81 or 372 80 + 375 15	250	250	250	6.3	6.3	6.3			
372 82	500	300	300	15	15	15			
372 83									
372 84									
372 85									
372 86									

IEC 60947-7-1/7-3, CSA no. 22-2 no. 158, UL 1059

Power according to EN 60947-7-3

Cat.Nos	Short-circuit		Short-circuit + overload	
	Separate blocks	Assembled blocks	Separate blocks	Assembled blocks
372 81 ou 372 80 + 375 15 ⁽¹⁾	4 W / 6.3 A Pvk = 4.75 W	1.6 W / 6.3 A Pvk = 2 W	1.6 W / 6.3 A Pv = 1.65 W	-

(1): With or without blown fuse indicator Cat.No 375 25

Cat.No 372 80

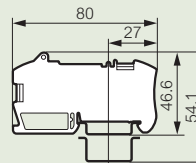

Cat.Nos 372 81/82/83/85

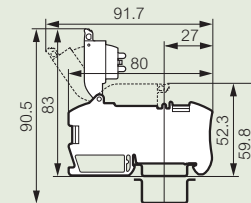

Cat.No 372 84/86

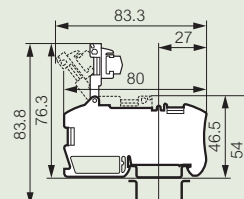

accessories for terminal blocks Viking™ 3

Stripped lengths (mm)

Spring terminal pitch (mm)	Rigid or flexible wire
5	8 to 12
6	
8	
10	8 to 13
12	8 to 15

Protection against fire and panic risks in public buildings/UTE C 12-201 guide

Art. EL 3, definitions: "Security installations are those that have to be put into or maintained in service to ensure the evacuation of the public or facilitate the intervention of the first-aid"

Art. EL 16, power supply circuits in security installations section 1a: "...the corresponding junction or deviation devices and their enclosures, except for the waterproofing systems, must satisfy the incandescent wire test defined in the standard in force, the temperature of the incandescent wire being 960 °C"

Viking 3 terminal blocks satisfy the incandescent wire test 960 °C according to standard IEC 60695-2-11

■ Characteristics and dimensions (mm)

End stops

Cat.No 375 10

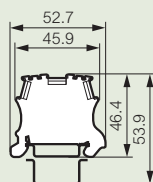

Cat.No 375 11

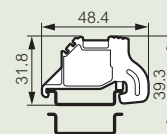

Cat.No 375 12

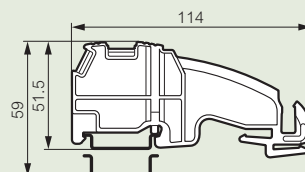

Cat.No 375 13

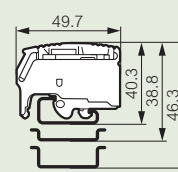

End caps

Cat.Nos	Thickness (mm)
375 50	2
375 51	2.5
375 52	2
375 53	2
375 54	2.5
375 55	2
375 56	1.4
375 57	1.4
375 58	1
375 59	1.1
375 60	1.1
375 61	1.1
375 62	1.1
375 63	1.1
375 64	1.1
375 65	1.1
375 66	1.1
375 67	1.1
375 68	1.1
375 69	1.1
375 70	1.1
375 71	1.1
375 72	1.1
375 73	1.1
375 74	1.1
375 75	1.1
375 76	1.1
375 77	1.1
375 78	1.1
375 79	1.1
375 80	1.1
375 81	1.1
375 82	1.1
375 83	1.1
375 84	1.1
375 85	1.1
375 86	1.1
375 87	1.1
375 88	1.1
375 89	1.1
375 90	2

Separation and insulation dividers

Cat.Nos	Thickness (mm)
375 54	2.5
375 60	2.5
375 61	2.6
375 62	2.5
375 63	2.5
375 95	2.8
375 96	2.7

Equipotential bridging combs/bars

Cat.Nos	Cross-section (mm²)
375 01	2.5
375 02	2.5
375 04	4
375 05	4
375 07	6
375 08	6
375 40	10
375 42	16
375 44	35
375 46	2.5
375 47	2.5
375 82	10
375 85	16

Shielding clamps

Mounting on bar
10 x 3 Cat.No 375 34

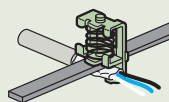

Mounting on rail
with accessory
Cat.No 364 69

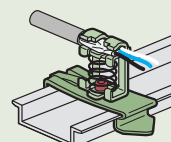

Mounting on plate

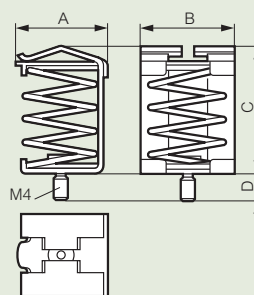
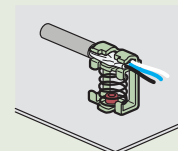

Cat.Nos	A	B	C	D
375 30	13.5	18	26	5.6
375 31	20	20.3	31.4	5.3
375 32	24.8	26	40	5.3

Viking™ 3 power terminal blocks

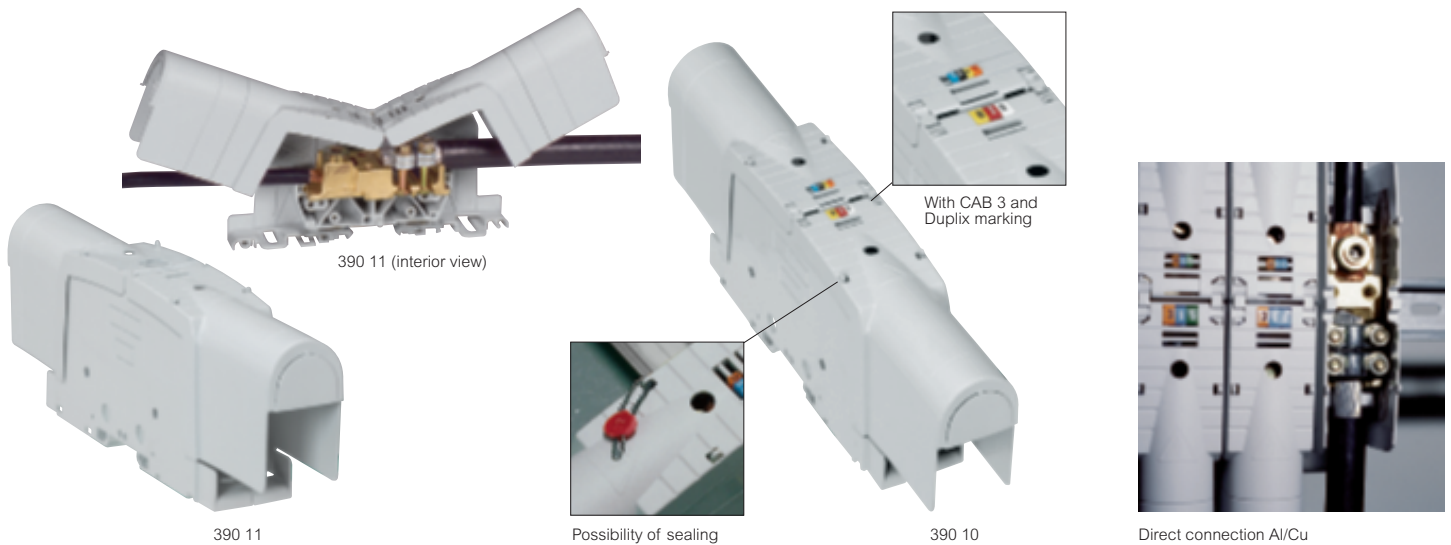

Pack	Cat.Nos	For copper and aluminium cables		
		Bridging the gap between the enclosure and external cables Fixed using metal clip for rails \sqsubset 15 mm depth and \sqsubset EN 60715 15 mm depth, or on plate with screws Fitted with covers with cut-outs Permits the use of Cab 3, Duplix markers Test via test plug \varnothing 4 closed covers Blocks with identical pitch can be joined using a threaded rod Supports shunt with Cat.Nos 394 46/47		
		Cable/cable	Rigid or flexible connecting cable (mm ²)	Pitch (mm)
5	390 10	Al/Cu	35 to 120	42
5	390 11	Al/Cu	70 to 300	55
		Cable lug/cable lug	Connecting plate max. (mm ²)	Pitch (mm)
5	390 13	Al/Cu	95	36
5	390 14	Al/Cu	150	42
5	390 15	Al/Cu	300	55
		Cable lug/cable	Connecting plate max. (mm ²)	Pitch (mm)
5	390 17	Al/Cu	150	42
5	390 18	Al/Cu	300	55
		Cable/cable lug	Connecting plate max. (mm ²)	Pitch (mm)
5	390 20	Cu	35 to 120	42
5	390 21	Al	35 to 120	42
			Al/Cu	70
			Al/Cu	300
			Al/Cu	150

Pack	Cat.Nos	Accessories for power terminal blocks for copper and aluminium cables	
5	394 46	Shunt	
5	394 47	For blocks with pitch 36 and 42 mm	
		For blocks with pitch 55 mm	

Pack	Cat.Nos	For bars or lugs			
		Bridging the gap between the enclosure and external cables With cable lug. Plastic foot For use with terminal marker sheets			
		For symmetrical rails			
		Fixed using metal clip on rails \sqsubset 15 mm depth and \sqsubset EN 60715 15 mm depth			
		Connecting max. (mm ²)	Width of plate (mm)	Screw \varnothing	Pitch (mm)
5	390 71	35	15	M 8	26
5	390 72	70	20	M 10	34
5	390 73	120	25	M 10	34
5	390 74	240	35	M 12	46
		For asymmetrical rails			
		Fixed using metal clip on rails \sqsubset EN 60715			
5	390 31	35	15	M 8	26
5	390 32	70	20	M 10	34
5	390 33	120	25	M 10	34
5	390 34	240	35	M 12	46
		Accessories for plate power terminal blocks			
		Separation barriers			
		Take protective covers Marking possible with CAB 3			
10	394 77	For blocks with pitch 26 mm			
10	394 78	For blocks with pitch 34 and 46 mm			
		Protective covers			
		For mounting on separation barriers			
5	394 86	For 3 blocks with pitch 46 mm or for 4 blocks with pitch 34 mm			
5	394 88	For 4 blocks with pitch 26 mm			
5	394 89	For 4 blocks with pitch 46 mm			



End stops (p. 19)

Viking™ 3 power terminal blocks

■ Characteristics of power terminal blocks for copper and aluminium cables

IK 04
 Conform to IEC EN 60947-7-1
 UL 1059 and 486 E - CSA 22-2
 Fire resistant IEC EN 60695-2-11: 960°C (except cover)
 V2 according to UL 94
 Insulation voltage U_i : 1000 V
 Impulse voltage U_{imp} : 12 kV
 Insulating material:
 - polyamide body -30°C to +100°C
 - polypropylene cover -25°C to +100°C

Connection table

Cat.Nos	Connection (mm ²)	Width of plate (mm)	Screw \varnothing	Connection (mm ²)	Width of plate (mm)	Screw \varnothing
Cable - Cable						
390 10	Rigid or flexible Cu/Al: 35 to 120			Rigid or flexible Cu: 35 to 70		
390 11	Rigid or flexible Cu/Al: 70 to 300			Rigid or flexible Cu: 70 to 150		
Cable lug - Cable lug						
390 13	Cu/Al: max. 95	28	M 8	Cu/Al: max. 95	28	M 8
390 14	Cu/Al: max. 150	34	M 10	Cu/Al: max. 150	34	M 10
390 15	Cu/Al: max. 300	46	M 12	Cu/Al: max. 300	46	M 12
Cable lug - Cable						
390 17	Cu/Al: max. 150	34	M 10	Rigid or flexible Cu: 35 to 95		
390 18	Cu/Al: max. 300	46	M 12	Rigid or flexible Cu: 70 to 150		
Cable - Cable lug						
390 20	Rigid or flexible Cu: 35 to 120 Al: 35 to 120			Cu/Al: max. 120 Cu/Al: max. 70	34	M 10
390 21	Rigid or flexible Cu: 70 to 300 Al: 70 to 300			Cu/Al: max. 300 Cu/Al: max. 150	46	M 12

Cable - cable

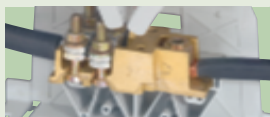

Terminal for cable lug - cable



Terminal for cable lug - terminal for cable lug



Cable - terminal for cable lug

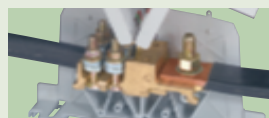

Currents table

Cat.Nos	Current (A)				Short-circuit current (kA)		Tightening torque (Nm)	
	Shunted input		I/O currents		Shunted input	I/O	Site	Factory
	IEC	IEC	CSA	UL				
Cable - Cable								
390 10	340	250	200	175	14.4	8.4	15	15
390 11	570	400	300	285	36	18	35	35
Cable lug - Cable lug								
390 13	310	310	250	230	11.4	11.4	15	15
390 14	415	415	340	285	18	18	15	15
390 15	670	670	520	420	36	36	35	35
Cable lug - Cable								
390 17	415	315	210	230	18	11.4	15	15
390 18	670	420	325	285	36	18	35	35
Cable - Cable lug								
390 20	340	340	235	255	14.4	8.4	15	15
390 21	570	570	375	420	36	18	35	35
Shunts								
394 46	450 max.							6
394 47	700 max.							10

Cable section equivalence table

mm ²	35	70	95	120	150	185	300
AWG	2	00	0000	250	300	350	600

Dimensions (mm)

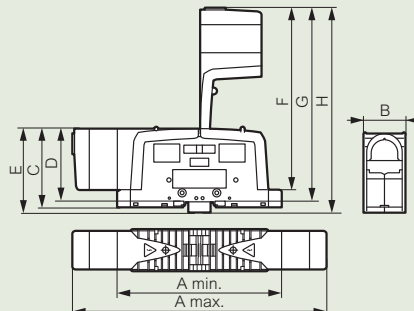

Cat.Nos	A max.	A min.	B	C	D	E	F	G	H
390 13	227	155	36	82	73	88	176	185	191
390 10/14/17/20	296	200	42	83.5	74.5	89.5	212	221	227
390 11/15/18/21	337	216	55	107.3	98.5	113.5	257	266	272

■ Characteristics of bars or lugs power terminal blocks

Cat.Nos	Voltage (V) IEC	Intensity (A) IEC	IEC EN 60947-7-1 Fire resistance: 960°C, IEC EN 60695-2-11 V2 according to UL 94 Insulating material: polyamide - 30 °C to + 100 °C
390 31/71	1000	125	
390 32/72	1000	192	
390 33/73	1000	269	
390 34/74	1000	415	

Dimensions (mm)

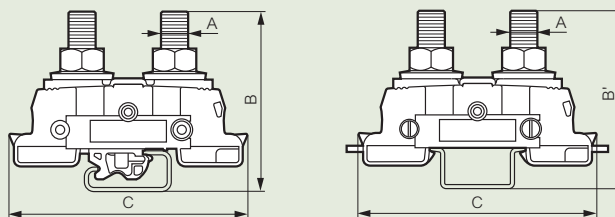

Cat.Nos 390 31/32/33/34

Cat.Nos 390 71/72/73/74

Cat.Nos	A	B	B'	C
390 31	M 8	56		84
390 32	M 10	61		84
390 33	M 10	61		84
390 34	M 12	64		86
390 71	M 8		55.3	84
390 72	M 10		60.4	84
390 73	M 10		60.4	84
390 74	M 12		63.5	86

■ Separation barriers

Dimensions (mm)

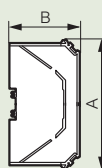

Cat.Nos 394 77/78

Cat.Nos	A	B	Th.
394 77	106	82	8
394 78	188	102	12

CAB 3™ marking and isolating sleeves

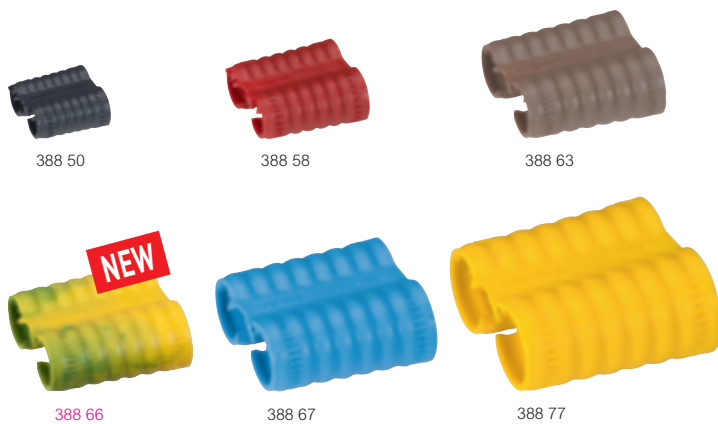

For colour-marking cables and isolating lug tubes from 10 mm² to 300 mm²
Fitting and removal without tool before or after connection

Pack	Cat.Nos	Sleeves	
		Conductor Ø7.1 to 10.5 mm	
		Cross-section 10 to 25 mm ²⁽¹⁾	
		Colour	Length (mm)
100	388 49	blue	20
100	388 50	black	
100	388 51	brown	
100	388 52	red	
100	388 53	yellow	
100	388 54	yellow/green	
		Conductor Ø10 to 13.5 mm	
		Cross-section 25 to 50 mm ²⁽¹⁾	
		Colour	Length (mm)
50	388 55	blue	29.5
50	388 56	black	
50	388 57	brown	
50	388 58	red	
50	388 59	yellow	
50	388 60	yellow/green	
		Conductor Ø13 to 17 mm	
		Cross-section 50 to 95 mm ²⁽¹⁾	
		Colour	Length (mm)
25	388 61	blue	38
25	388 62	black	
25	388 63	brown	
25	388 64	red	
25	388 65	yellow	
25	388 66	yellow/green	
		Conductor Ø16.5 to 23 mm	
		Cross-section 95 to 185 mm ²⁽¹⁾	
		Colour	Length (mm)
20	388 67	blue	46
20	388 68	black	
20	388 69	brown	
20	388 70	red	
20	388 71	yellow	
20	388 72	yellow/green	
		Conductor Ø22.5 to 29 mm	
		Cross-section 185 to 300 mm ²⁽¹⁾	
		Colour	Length (mm)
10	388 73	blue	55
10	388 74	black	
10	388 75	brown	
10	388 76	red	
10	388 77	yellow	
10	388 78	yellow/green	

(1) The values for cable cross section are just an example, the real values are depending on lugs and cable type

CAB 3™ marking and isolating sleeves

■ Characteristics

Material PA 6.6
Installation temperature: - 5°C to + 40°C
Operating temperature: - 25°C to + 105°C
Storage temperature: - 40°C to + 70°C
Incandescent wire test: 960°C
Dielectric cross resistance: 6KV

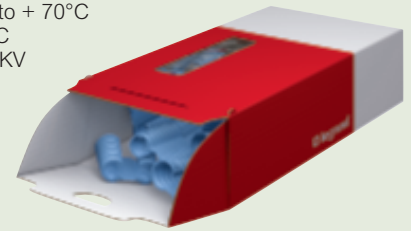

Supplied in dispenser box

■ Dimensions (mm)

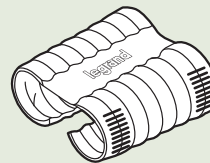
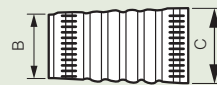
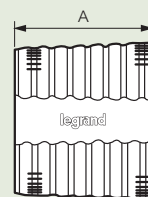

Cat.No	A	øB	øC
388 49 to 54	20.2	8.87	10.9
388 55 to 60	29.4	11.57	14.5
388 61 to 66	37.9	14.97	18.4
388 67 to 72	46.1	19.07	23.3
388 73 to 78	55.14	25.51	30.7

■ Installation



■ Example of use

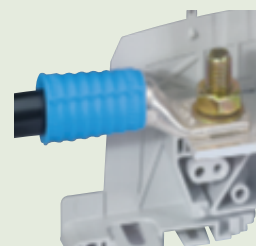

Example of use of sleeve
Cat.No 388 61 on a power
terminal block

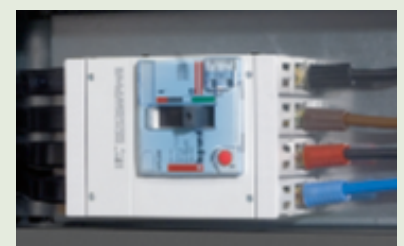

Use of a sleeve on a wired DPX 250

CAB 3™ marking system for wiring and Viking 3 terminal blocks



381 51



381 64

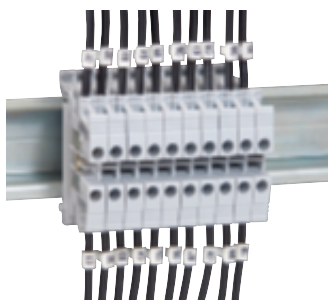

Same markers for cable and terminal blocks

Strips of 20 markers
For marking wiring or Viking 3 terminal blocks

Pack	Cat.Nos	Markers for wiring 0.5 to 1.5 mm ² cross-section and terminal blocks
240	381 50	Numbers: black on white background (available in black on yellow background on request) 01 to 20
240	381 51	21 to 40
240	381 52	41 to 60
240	381 53	61 to 80
240	381 54	81 to 100
240	381 55	Blank



381 51

Pack	Cat.Nos	Markers for wiring 1.5 to 2.5 mm ² cross-section and terminal blocks
240	381 60	Numbers: black on white background (available in black on yellow background on request) 01 to 20
240	381 61	21 to 40
240	381 62	41 to 60
240	381 63	61 to 80
240	381 64	81 to 100
240	381 65	Blank



381 64

marking label sheets for Viking 3 terminal blocks

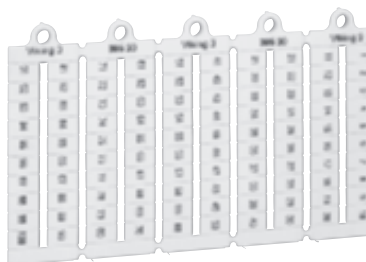

395 20



395 98

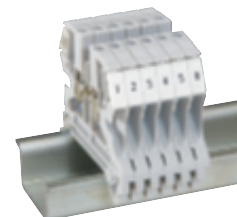

395 05 on Viking 3 terminal blocks

Pack	Cat.Nos	Blank markers
1000	395 00	Displayed by sheet of 100 pre-cut markers Manual marking or via Logicab 2 For blocks 5 mm pitch
1000	395 01	For blocks 6 mm pitch
1000	395 02	For blocks 8 mm pitch

Numbers Reading of installed marker

Horizontal format

Pitch of 5 mm

1000	395 05	From 1 to 10 (10 times)
1000	395 06	From 11 to 20 (10 times)
1000	395 07	From 21 to 30 (10 times)
1000	395 08	From 31 to 40 (10 times)
1000	395 09	From 1 to 50 (2 times)
1000	395 10	From 1 to 100
1000	395 11	From 101 to 200

Pitch of 6 mm

1000	395 15	From 1 to 10 (10 times)
1000	395 16	From 11 to 20 (10 times)
1000	395 17	From 21 to 30 (10 times)
1000	395 18	From 31 to 40 (10 times)
1000	395 19	From 1 to 50 (2 times)
1000	395 20	From 1 to 100
1000	395 21	From 101 to 200

Pack	Cat.Nos	Black felt tip pen
10	395 98	Indelible for marking

CAB 3™ marking system

markers for wiring and Viking 3 terminal blocks

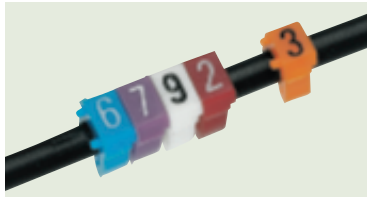

Perfect alignment of label holders



382 12

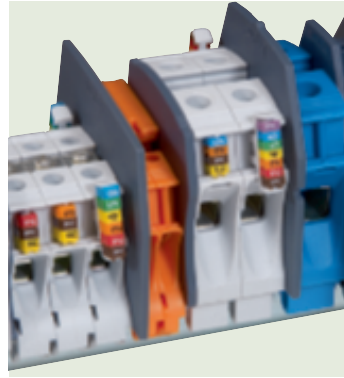

Terminal block with CAB 3 markers and label-holders

Pack	Cat.Nos		Markers for wiring 0.15 to 0.5 mm ² and 0.5 to 1.5 mm ² cross-section and terminal blocks	
			On Viking 3 terminal blocks - 4 markers 0.15 to 0.5 mm ² max. - 3 markers 0.15 to 1.5 mm ² max. Pack: - Up to 0.5 mm ² : strips of 25 markers From 0.5 mm ² to 2.5 mm ² : strips of 30 markers - Upper 2.5 mm ² : strips of 20 markers Price per marker	
			Digits : international colour code	
			381 06	
			Letters : black on yellow background	
			383 17	
			381 28	
			Conventional symbols : black on yellow background	
			382 72	
			381 43	

Pack	Cat.Nos		Markers for wiring 1.5 to 2.5 mm ² and 4 to 6 mm ² cross-section	
			Pack: - Up to 0.5 mm ² : strips of 25 markers From 0.5 mm ² to 2.5 mm ² : strips of 30 markers - Upper 2.5 mm ² : strips of 20 markers Price per marker	
			Digits : international colour code	
			382 32	
			382 26	
			Letters : black on yellow background	
			383 60	
			383 79	
			Conventional symbols : black on yellow background	
			382 90	
			382 96	

accessories CAB 3™ marking system

CAB 3™ marking system

for wiring and Viking 3 terminal blocks



Pack	Cat.Nos	Accessories CAB 3
		Marker-holders
		For cables cross-section from 10 mm ² to 70 mm ² Capacity: 8 digits, letters or symbols markers from 0.5 to 1.5 mm ² or 1.5 to 2.5 mm ² cross section Black, cross-section (mm ²)
100	384 90	10 to 16
50	384 91	25 to 35
50	384 92	50 to 70
		Support for markers
		Can be clipped on Viking 3 terminal blocks Capacity: 7 markers from 0.15 to 0.5 mm ² 6 markers from 0.5 to 1.5 mm ²
100	383 92	
		Transparent applicators
		For rapid selection and application of markers onto cable
		For markers cross-section (mm ²) Applicator colour for identification of cross-section
10	383 94	0.15 to 0.5 CAB 3
10	383 95	0.5 to 1.5 CAB 3
10	383 96	1.5 to 2.5 CAB 3
10	383 97	4 to 6 CAB 3
		Set of markers
1	382 01	0.15 to 0.5 mm ² : 2 500 markers + 10 applicators (250 digits from 0 to 9)
1	382 02	0.5 to 1.5 mm ² : 3 000 markers + 10 applicators (300 digits from 0 to 9)
1	382 03	1.5 to 2.5 mm ² : 3 000 markers + 10 applicators (300 digits from 0 to 9)
1	382 04	4 to 6 mm ² : 2 000 markers + 10 applicators (200 digits from 0 to 9)
		On-site toolbox
1	382 00	With removable tray for CAB 3 markers and applicators, Starfix ferrules... Height 85 mm, depth 280 mm, width 450 mm Metal, padlockable

■ Dimensions

Markers

Polyamide 6/6

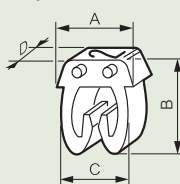

Dimensions	Cable cross-section (mm ²)			
	0.15 to 0.5	0.5 to 1.5	1.5 to 2.5	4 to 6
A (mm)	5	5	5.6	8
B (mm)	5.05	6.4	7.6	9.6
C (mm)	3.7	4.3	4.9	7.1
D (mm)	2.3	3	3	3
Ø min./max. (mm)	0.8/2.2	2.2/3	2.8/3.8	4.3/5.3

Cat.Nos 381 50 to 381 55 et 381 60 to 381 65: no liking stud.
D = 6 mm

Marker holders

Cat.No 384 90

Cat.No 384 91

Cat.No 384 92

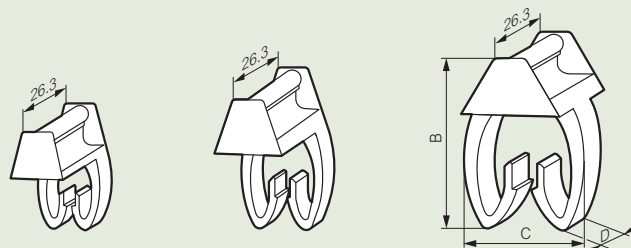

Dim.	Section of cable for marking (mm ²)		
	10 to 16	25 to 35	50 to 70
A (mm)	18	24.3	27.2
B (mm)	8.9	12.2	17.2
C (mm)	7	7	10

Support for markers Cat.No 383 92

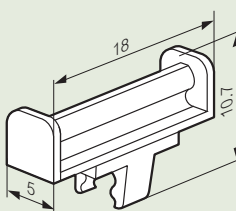

On cable with marker-holder Cat.No 384 92

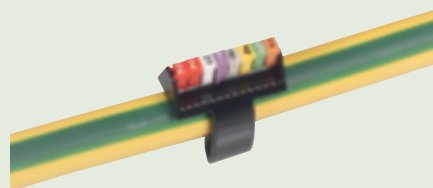

■ Characteristics and dimensions of on-site toolbox

Cat.No 382 00

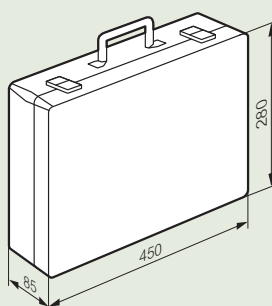

Bottom tray consists of:

- 8 medium slots (each slot takes 1 box of CAB 3)
- 1 large slot

Top tray consists of:

- 12 small slots (<=> approx. 6 boxes of CAB 3)
 - 1 medium slot for applicators
- Capacity: approx. 15000 CAB 3 markers

On terminal blocks, with support Cat.No 383 92



On power terminal blocks

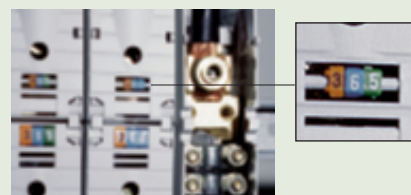

Starfix™ ferrules and crimping tools

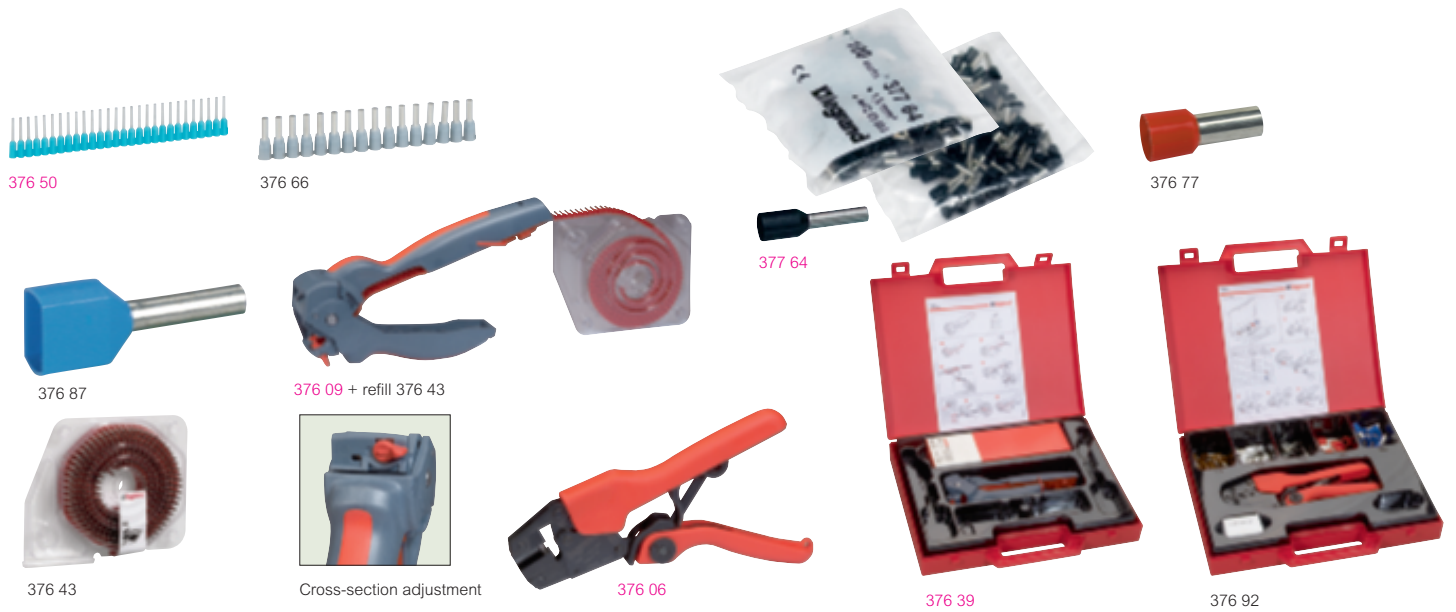

Pack	Cat.Nos	Ferrules with insulating flange			
		Provide an equipotential link for all the strands of a flexible conductor Active part in tinned electrolytic copper Conform to NF C 63-023			
		Simples in strips			
		For-cables cross-section (mm ²)	Colour	Strips	Ferrules
500	376 50	0.25	turquoise	10	50
500	376 60	0.34	green	12	40
480	376 61	0.5	white	12	40
480	376 62	0.75	blue	12	40
1000	376 63	1	red	25	40
1000	376 64	1.5	black	25	40
1000	376 66	2.5	grey	25	40
250	376 67	4	orange	10	25
250	376 68	6	green	10	25
		Simples individuals (sachet packing)			
500	377 50	0.25	turquoise	5	100
500	377 60	0.34	green	5	100
1000	377 61	0.5	white	10	100
1000	377 62	0.75	blue	10	100
1000	377 63	1	red	10	100
1000	377 64	1.5	black	10	100
1000	377 66	2.5	grey	10	100
250	377 67	4	orange	5	50
250	377 68	6	green	5	50
		Simples individuals (box packing)			
100	376 69	10	brown		
100	376 72 ⁽¹⁾	16	white		
100	376 70	16	white		
50	376 71	25	black		
50	376 77	35	red		
30	376 78	50	blue		
		Doubles individuals			
100/500	376 87	2 x 0.75	blue		
100/500	376 88	2 x 1	red		
100/500	376 89	2 x 1.5	black		
100/500	376 90	2 x 2.5	grey		

Large capacity Starfix refills				
Large capacity for less frequent applicator reloading Translucent packaging For direct mounting on crimping tool Cat.No 376 09				
		Cross-section (mm ²)	Colour	Number of ferrules per strip
3 000	376 41	0.5	White	300
3 000	376 42	0.75	Blue	300
3 000	376 43	1	Red	300
3 000	376 44	1.5	Black	300
2 500	376 45	2.5	Grey	250

Pack	Cat.Nos	Crimping tools for ferrules in strips	
		Cut and carry out 4-point crimping of ferrules from 0.25 to 6 mm ² in one operation Use recommended for spring connections Dedicated applicator for each crimping tool for dispensing strips	
1	376 08	Starfix crimping tool for 0.25 and 0.34 mm² cross-sections Supplied fitted with empty applicator	
1	376 09	Starfix crimping tool for 0.5 to 2.5 mm² cross-sections Fitted with an adjustment wheel Supplied fitted with empty applicator	
1	376 39	Assorted kit, comprising: - 1 Starfix crimping tool, Cat. No. 376 09 fitted with empty applicator - 120 x 0.5 mm ² ferrules - 120 x 0.75 mm ² ferrules - 240 x 1 mm ² ferrules - 320 x 1.5 mm ² ferrules - 200 x 2.5 mm ² ferrules	
1	376 10	Starfix crimping tool for 4 and 6 mm² cross-sections Fitted with an adjustment wheel Supplied complete with empty applicator	
1	376 97	Starfix S multi-purpose crimping tool for 0.5 to 2.5 mm² cross-sections Tool cuts, strips, twists, crimps Supplied complete with 5 empty applicators For left and right-handed persons	
		Crimping tool for individual single and double ferrules	
1	376 06	Starfix crimping tool for 0.25 to 6 mm² cross-sections For 4-point crimping of ferrules from 0.25 to 6 mm ² Use recommended for spring connections Crimping tool with disengageable control system, crimping at end Right or left-handed	
1	376 92	Starfix clamp for 10 to 50 mm² cross-section Assorted kit: supplied comprising: - 1 tool with crimping operation control system for individual ferrules 10 to 50 mm ² - 30 individual ferrules 10 mm ² - 20 individual ferrules 16 mm ² - 15 individual ferrules 25 mm ² - 10 individual ferrules 35 mm ² - 10 individual ferrules 50 mm ²	

(1) Short ferrule

Starfix™ applicator

NEW



376 47

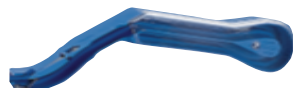

376 81

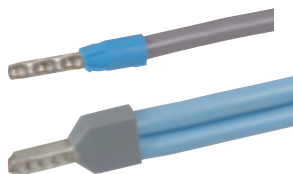

Example of simple/double ferrules on wires



Example of different wires and ferrules

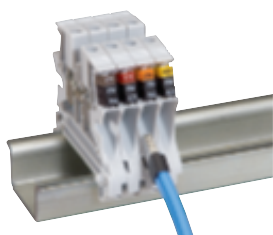

Pack	Cat.No	Starfix applicator
10	376 46	For Starfix crimping tool For dispensing strips of ferrules in Starfix crimping tools Cat.Nos 376 08/09/10 For ferrules cross-section (mm ²) Colour 0.25 et 0.34 yellow 0.5 à 2.5 red 4 et 6 orange
10	376 47	
10	376 48	

Starfix™ applicator

■ Correspondence table

Cross-section (mm ²)			
	Simple ferrule	Large capacity ferrule - refills	Starfix applicator
0.5	376 61	376 41	376 47
0.75	376 62	376 42	376 47
1	376 63	376 43	376 47
1.5	376 64	376 44	376 47
2.5	376 66	376 45	376 47

■ Dimensions (mm)

Simple ferrules

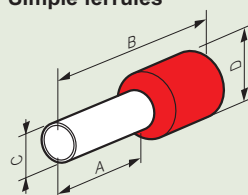

Cat.Nos			Cross-section (mm ²)	A	B	C	D
376 50	377 50						
376 60	377 60		0.34	8	14.5	1.1	3
376 61	377 61	376 41	0.5	8	14.5	1.5	3.4
376 62	377 62	376 42	0.75	8	14.5	1.5	3.4
376 63	377 63	376 43	1	8	14.5	1.7	3.6
376 64	377 64	376 44	1.5	8	14.5	2	4.1
376 66	377 66	376 45	2.5	8	14.5	2.6	4.8
376 67	377 67		4	12	21	3.2	5.7
376 68	377 68		6	12	23	3.9	7.2
376 69			10	12	21	4.9	8.1
376 72			16	12	23	6.3	9.8
376 70			16	18	29	6.3	9.8
376 71			25	18	31	7.9	12
376 77			35	18	32	8.9	13.5
376 78			50	20	36	11.1	16.1

Double ferrules

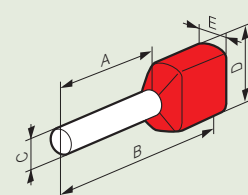

Cat.Nos	Cross-section (mm ²)	A	B	C	D	E
376 87	2 x 0.75	8	15	2.1	6	3.3
376 88	2 x 1	8	15	2.35	6	4
376 89	2 x 1.5	8	16	2.6	7.2	4.2
376 90	2 x 2.5	10	18.5	3.3	8.4	4.8

■ Example of use Starfix tool



1 Fit the applicator



2 Adjust



The 2-material handle gives an excellent grip

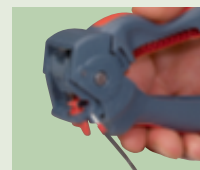

3 Insert the wire



4 Crimp

Starfix S tool

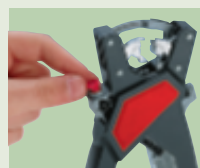

1 Adjust the cross-section

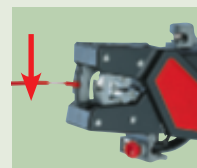

2 Strip and twist

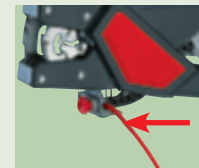

3 Crimp

Catalogue number index

Cat.Nos	Page No.	Pack	Cat.Nos	Page No.	Pack	Cat.Nos	Page No.	Pack	Cat.Nos	Page No.	Pack	Cat.Nos	Page No.	Pack
371 00			372 09	16	50	375 25	19	10/50	376 62	30	480	381 29	28	300
371 00	14	60	10	-	40	27	-	10	63	-	1000	30	-	300
01	-	50	11	-	30	30	-	10	64	-	1000	31	-	300
02	-	40	12	-	40	31	-	10	66	-	1000	32	-	300
03	-	30	20	-	60	32	-	4	67	-	250	33	-	300
04	-	20	21	-	50	34	-	10	68	-	250	34	-	300
05	-	20	40	-	60	35	-	50	69	-	100	35	-	300
07	-	60	41	-	60	40	-	10	70	-	100	40	-	300
08	-	60	42	-	60	42	-	10	71	-	50	41	-	300
09	-	25	43	-	50	44	-	10	72	-	100	42	-	300
20	-	60	44	-	50	46	-	10	77	-	50	43	-	300
21	-	50	46	-	60	47	-	10	78	-	30	44	-	300
30	-	60	47	-	60	50	18	100	87	-	100/500	45	-	300
31	-	50	54	17	60	51	-	20	88	-	100/500	46	-	300
51	-	50	55	-	60	52	-	20	89	-	100/500	50	27	240
52	-	50	56	-	60	53	-	20	90	-	100/500	51	-	240
53	15	20	60	16	60	54	-	20	92	-	1	52	-	240
54	-	20	61	-	50	55	-	20	97	-	1	53	-	240
55	-	60	62	-	50	56	-	20	377 00			54	-	240
56	-	60	63	-	40	57	-	10	377 50	30	500	55	-	240
60	14	60	64	-	10	60	-	20	60	-	500	60	-	240
61	-	50	67	-	60	61	-	10	61	-	480	61	-	240
62	-	40	68	-	50	62	-	10	62	-	480	62	-	240
63	-	30	69	-	50	63	-	10	63	-	1000	63	-	240
64	-	20	70	-	60	65	19	10	64	-	1000	64	-	240
65	-	20	71	-	50	66	-	10	66	-	1000	65	-	240
66	-	10	72	-	25	67	-	10	67	-	250	382 00		
67	-	60	73	-	20	68	-	10	68	-	250	382 00	29	1
68	-	60	74	-	15	69	-	10	381 00			01	-	1
69	-	25	79	-	30	75	-	50	381 00	28	1000	02	-	1
70	-	60	80	17	20	76	-	20	01	-	1000	03	-	1
71	-	50	81	-	20	77	-	10	02	-	1000	04	-	1
72	-	40	82	-	20	82	-	20	03	-	1000	10	28	1200
73	-	30	83	-	20	85	-	20	04	-	1000	11	-	1200
74	-	10	84	-	20	86	18	50	05	-	1000	12	-	1200
75	-	10	85	-	20	87	-	50	06	-	1000	13	-	1200
76	-	10	86	-	20	88	-	20	07	-	1000	14	-	1200
77	-	50	374 00			89	-	20	08	-	1000	15	-	1200
78	-	40	374 04	18	10	90	-	20	09	-	1000	16	-	1200
79	-	50	07	-	10	95	-	10	10	-	300	17	-	1200
80	15	20	375 00			96	-	10	11	-	300	18	-	1200
81	-	20	375 01	18	20	376 00			12	-	300	19	-	1200
82	-	20	02	-	50	376 06	30	1	13	-	300	20	-	1200
83	-	20	04	-	20	08	-	1	14	-	300	21	-	1200
84	-	20	05	-	50	09	-	1	15	-	300	22	-	1200
85	-	20	07	-	20	10	-	1	16	-	300	23	-	1200
86	-	20	08	-	20	39	-	1	17	-	300	24	-	1200
87	-	20	10	-	50	41	-	3000	18	-	300	25	-	1200
88	-	20	11	-	20	42	-	3000	19	-	300	26	-	1200
92	-	25	12	-	10	43	-	3000	20	-	300	27	-	1200
372 00			13	-	20	44	-	3000	21	-	300	28	-	1200
372 00	16	60	15	19	10/50	45	-	2500	22	-	300	29	-	1200
01	-	50	16	-	10/50	46	31	10	23	-	300	30	-	800
02	-	50	17	-	10/50	47	-	10	24	-	300	31	-	800
03	-	40	18	-	10/50	48	-	10	25	-	300	32	-	800
04	-	10	21	-	20	50	30	500	26	-	300	33	-	800
07	-	60	22	-	20	60	-	500	27	-	300	34	-	800
08	-	50	24	-	10/50	61	-	480	28	-	300	35	-	800

Cat.Nos	Page No.	Pack	Cat.Nos	Page No.	Pack	Cat.Nos	Page No.	Pack	Cat.Nos	Page No.	Pack	Cat.Nos	Page No.	Pack
382 36	28	800	383 14	28	300	383 62	28	300	388 55	26	50	390 73	24	5
37	-	800	15	-	300	63	-	300	56	-	50	74	-	5
38	-	800	16	-	300	64	-	300	57	-	50	394 00		
39	-	800	17	-	300	65	-	300	58	-	50	394 45	19	1/10
70	-	300	18	-	300	66	-	300	59	-	50	46	24	5
71	-	300	19	-	300	67	-	300	60	-	50	47	-	5
72	-	300	20	-	300	68	-	300	61	-	25	49	18	10
73	-	300	21	-	300	69	-	300	62	-	25	77	24	10
74	-	300	22	-	300	70	-	300	63	-	25	78	-	10
75	-	300	23	-	300	71	-	300	64	-	25	86	-	5
76	-	300	24	-	300	72	-	300	65	-	25	88	-	5
80	-	300	25	-	300	73	-	300	66	-	25	89	-	5
81	-	300	30	-	300	74	-	300	67	-	20	395 00		
82	-	300	31	-	300	75	-	300	68	-	20	395 00	27	1000
83	-	300	32	-	300	76	-	300	69	-	20	01	-	1000
84	-	300	33	-	300	77	-	300	70	-	20	02	-	1000
85	-	300	34	-	300	78	-	300	71	-	20	05	-	1000
86	-	300	35	-	300	79	-	300	72	-	20	06	-	1000
90	-	300	36	-	300	80	-	300	73	-	10	07	-	1000
91	-	300	37	-	300	81	-	300	74	-	10	08	-	1000
92	-	300	38	-	300	82	-	300	75	-	10	09	-	1000
93	-	300	39	-	300	83	-	300	76	-	10	10	-	1000
94	-	300	40	-	300	84	-	300	77	-	10	11	-	1000
95	-	300	41	-	300	85	-	300	78	-	10	15	-	1000
96	-	300	42	-	300	92	29	100	390 00			16	-	1000
383 00			43	-	300	94	-	10	390 10	24	5	17	-	1000
383 00	28	300	44	-	300	95	-	10	11	-	5	18	-	1000
01	-	300	45	-	300	96	-	10	13	-	5	19	-	1000
02	-	300	46	-	300	97	-	10	14	-	5	20	-	1000
03	-	300	47	-	300	384 00			15	-	5	21	-	1000
04	-	300	48	-	300	384 90	29	100	17	-	5	96	18	20
05	-	300	49	-	300	91	-	50	18	-	5	97	-	20
06	-	300	50	-	300	92	-	50	20	-	5	98	18	10
07	-	300	51	-	300	388 00			21	-	5	477 00		
08	-	300	52	-	300	388 49	26	100	31	-	5	477 22	18	10
09	-	300	53	-	300	50	-	100	32	-	5	23	-	10
10	-	300	54	-	300	51	-	100	33	-	5			
11	-	300	55	-	300	52	-	100	34	-	5			
12	-	300	60	-	300	53	-	100	71	-	5			
13	-	300	61	-	300	54	-	100	72	-	5			

In accordance with its policy of continuous improvement, the Company reserves the right to change specifications and designs without notice. All illustrations, descriptions, dimensions and weights in this catalogue are for guidance and cannot be held binding on the Company.

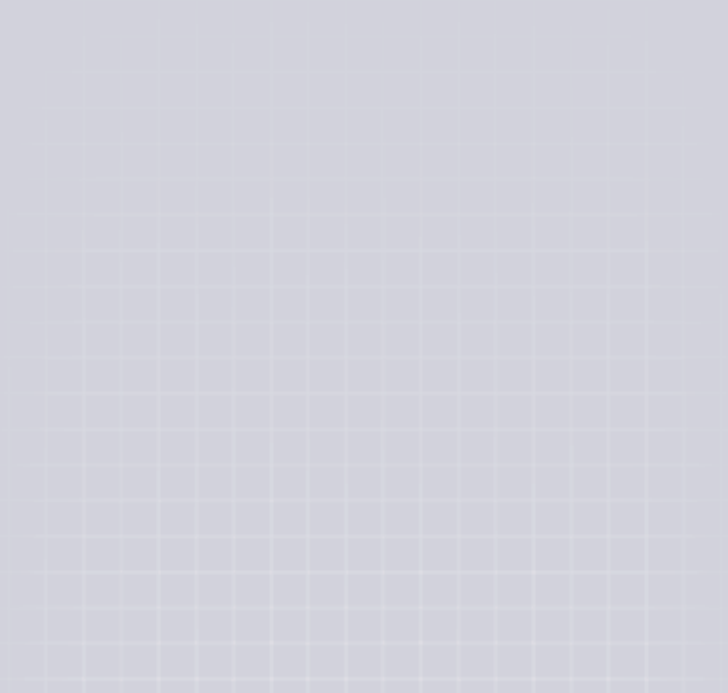

Headquarters

LEGRAND SNC

87045 Limoges Cedex - France

☎ : + 33 5 55 06 87 87

Fax : + 33 5 55 06 74 55

www.legrandgroup.com